

JVC

INSTRUCTIONS

DR-MX10SE

VHS & HDD & DVD VIDEO RECORDER

GUIDEplus™ **SHOWVIEW™** **HDD**
GEM STAR

DVD
VIDEO
RAM/RW

COMPACT
disc
SUPER VIDEO

RW 2

dts
DIGITAL OUT

DOLBY
DIGITAL



SQP B

Hi-Fi

VHS
PAL



LPT1072-001A

EN

Safety Precautions

The rating plate and the safety caution are on the side of the unit.

IMPORTANT:

- * Please read the various precautions on this and next pages before installing or operating the unit.
- * It should be noted that it may be unlawful to re-record prerecorded tapes, DVDs, or discs without the consent of the owner of copyright in the sound or video recording, broadcast or cable programme and in any literary, dramatic, musical, or artistic work embodied therein.

WARNING:

**DANGEROUS VOLTAGE INSIDE
TO PREVENT FIRE OR SHOCK HAZARD, DO NOT
EXPOSE THIS UNIT TO RAIN OR MOISTURE.**

CAUTION:

A UNIT IS A CLASS 1 LASER PRODUCT. HOWEVER THIS UNIT USES A VISIBLE LASER BEAM WHICH COULD CAUSE HAZARDOUS RADIATION EXPOSURE IF DIRECTED. BE SURE TO OPERATE THE UNIT CORRECTLY AS INSTRUCTED.

WHEN THIS UNIT IS PLUGGED INTO THE WALL OUTLET, DO NOT PLACE YOUR EYES CLOSE TO THE OPENING OF THE DISC TRAY AND OTHER OPENINGS TO LOOK INTO THE INSIDE OF THIS UNIT.

USE OF CONTROLS OR ADJUSTMENTS OR PERFORMANCE OF PROCEDURES OTHER THAN THOSE SPECIFIED HEREIN MAY RESULT IN HAZARDOUS RADIATION EXPOSURE.

DO NOT OPEN COVERS AND DO NOT REPAIR YOURSELF.

REFER SERVICING TO QUALIFIED PERSONNEL.

CLASS 1 LASER PRODUCT

REPRODUCTION OF LABELS

WARNING LABEL INSIDE OF THE UNIT

CAUTION	CLASS 3B VISIBLE AND INVISIBLE LASER RADIATION WHEN OPEN. AVOID EXPOSURE TO THE BEAM.
ADVARSEL	KLASSE 3B SYNLIG OG USYNLIG LASERSTRÅLING VED ÅBNING. UNDGÅ UDSÆTTELSE FOR STRÅLING.
ADVARSEL	KLASSE 3B SYNLIG OG USYNLIG LASERSTRÅLING NÅR DEKSEL ÅPENS. UNNGÅ EKSPONERING FOR STRÅLING.
VARNING	KLASSE 3B SYNLIG OG OSYNLIG LASERSTRÅLING NÅR DENNA DEL ÄR ÖPPNAD. STRÅLEN ÄR FÄRLIG.
VARO!	KURSSI 3B NÄKYVÄ JA NÄKYMÄTÖN AVATTAESSA OLET ALTIINA LASERSÄTEILYLLE. ÄLÄ KATSO SÄTEESEN.

OR

CAUTION VISIBLE AND/OR INVISIBLE CLASS 1M LASER RADIATION WHEN OPEN DO NOT STARE INTO BEAM OR VIEW DIRECTLY WITH OPTICAL INSTRUMENTS.	ATTENTION RAYONNEMENT LASER VISIBLE ET/OU INVISIBLE DE CLASSE 1M UNE FOS OUVERT. NE PAS FIXER LE FASCEAU NI REGARDER DIRECTEMENT AVEC DES INSTRUMENTS OPTIQUES	ADVARSEL SYNLIG OG/ELLER USYNLIG KLASSE 1M-LASERSTRÅLING VED ÅBNING SE IKKE IND I STRÅLEN- HELLER IKKE MED OPTISKE INSTRUMENTER.	ADVARSEL SYNLIG OG/ELLER USYNLIG LASERSTRÅLING I KLASSE 1 M NÅR DEKSEL ÅPENS. IKKE STRIK INN I STRÅLEN ELLER SE OBERE MED OPTISKE INSTRUMENTER.	VARO! AVATTAESSA OLET ALTIINA NÄKYVÄLLE JÄI TAI NÄKYMÄTTÖMÄLLE LUOKAN 1M LASERSÄTEILYLLE. ÄLÄ KATSO SUORAAN SÄTEESEN IÄI TARKASTELE SITA OPTISEN LAITTEEN LÄIKI.	VARNING SYNLIG OCH/ELLER OSYNLIG LASERSTRÅLING KLASS 1M NÅR DENNA DEL ÄR ÖPPNAD. STIPRA EJ IN I STRÅLEN OCH BETRÄKTRA EJ STRÅLEN MED OPTISKA INSTRUMENT. IP41295-001A
---	---	---	--	---	--

PRECAUTION:

Failure to heed the following precautions may result in damage to the unit, remote control or disc.

1. DO NOT place the unit -
 - in an environment prone to extreme temperatures or humidity.
 - in direct sunlight.
 - in a dusty environment.
 - in an environment where strong magnetic fields are generated. In addition, do not place TVs or other appliances which tend to generate strong magnetic fields on top of the unit as it may cause picture disturbance.
 - on a surface that is unstable or subject to vibration.
2. DO NOT block the unit's ventilation openings or holes.

If the ventilation openings or holes are blocked by a newspaper or cloth, etc., the heat may not be able to get out.

When installing the equipment, make sure there is a space allowance of 10 cm or more on both sides, on top and at the rear of the equipment.
3. DO NOT place heavy objects on the unit or remote control.
4. DO NOT place anything which might spill on top of the unit or remote control.

(If water or liquid is allowed to enter this equipment, fire or electric shock may be caused.)
5. DO NOT expose the apparatus to dripping or splashing.
6. DO NOT use this equipment in a bathroom or places with water. Also DO NOT place any containers filled with water or liquids (such as cosmetics or medicines, flower vases, potted plants, cups, etc.) on top of this unit.
7. DO NOT place any naked flame sources, such as lighted candles, on the apparatus.
8. AVOID violent shocks to the unit during transport.

For Italy:

It is declared that this product, brand JVC, conforms to the Ministry Decree n. 548 of 28 Aug.'95 published in the Official Gazette of the Italian Republic n. 301 of 28 Dec.'95.

CAUTION:

- When you are not using the unit for a long period of time, it is recommended that you disconnect the power cord from the mains outlet.
- Dangerous voltage inside. Refer internal servicing to qualified service personnel. To prevent electric shock or fire hazard, remove the power cord from the mains outlet prior to connecting or disconnecting any signal lead or aerial.
- The mains plug shall remain readily operable.

ATTENTION:

This unit contains microcomputers. External electronic noise or interference could cause malfunctioning. In such cases, switch the unit off and unplug the mains power cord. Then plug it in again and turn the unit on. Take out the disc. After checking the disc, operate the unit as usual.

Information for Users on Disposal of Old Equipment**Attention:**

This symbol is only valid in the European Union.

**[European Union]**

This symbol indicates that the electrical and electronic equipment should not be disposed as general household waste at its end-of-life. Instead, the product should be handed over to the applicable collection point for the recycling of electrical and electronic equipment for proper treatment, recovery and recycling in accordance with your national legislation.

By disposing of this product correctly, you will help to conserve natural resources and will help prevent potential negative effects on the environment and human health which could otherwise be caused by inappropriate waste handling of this product. For more information about collection point and recycling of this product, please contact your local municipal office, your household waste disposal service or the shop where you purchased the product.

Penalties may be applicable for incorrect disposal of this waste, in accordance with national legislation.

(Business users)

If you wish to dispose of this product, please visit our web page www.jvc-europe.com to obtain information about the take-back of the product.

[Other Countries outside the European Union]

If you wish to dispose of this product, please do so in accordance with applicable national legislation or other rules in your country for the treatment of old electrical and electronic equipment.

MOISTURE CONDENSATION

Moisture in the air will condense on the unit when you move it from a cold place to a warm place, or under extremely humid conditions — just as water droplets form on the surface of a glass filled with cold liquid. In conditions where condensation may occur, disconnect the unit's power plug from the wall and keep it disconnected for a few hours to let the moisture dry, then turn on the unit.

DISCLAIMER OF LIABILITY

JVC shall not be liable for any loss relating to the unit's failure to properly record, store or playback any content (video, audio or otherwise) for any reason whatsoever. Any applicable warranties shall only cover replacement or repair of the effected unit, and shall not apply to recovery or replacement of lost content.

Precautions during Operation

The HDD will be spinning at high speed whenever this unit is on. So note especially the following points before use.

- **Do not subject to vibration or impact.**
Subjecting to excessive impact can cause not only recorded data to be corrupted but also damage to the HDD.
Scratches or dirt on the recording side of a disc may prevent proper playback and recording.
- **Do not pull out the power plug from the socket while this unit is operating.**
Cutting off the power suddenly while the HDD is operating can cause not only data corruption but also damage to the HDD. Be sure to turn off the unit before pulling out the power plug.

Effects from mobile phones

Using a mobile phone in the vicinity of the unit may cause picture vibration on the TV screen or change the screen to a blue back display.

Do not place objects that generate magnetic fields on top of this unit

Some TVs or other appliances generate strong magnetic fields. Do not place such appliances on top of the unit as it may cause picture disturbance.

ATTENTION:

- The STANDBY/ON button does not completely shut off mains power from the unit, but switches operating current on and off.
- When moving the product, press STANDBY/ON to turn off the power, and wait at least 30 seconds before unplugging the power cord. Then, wait at least 2 minutes before moving the product.
- When discarding batteries, environmental problems must be considered and the local rules or laws governing the disposal of these batteries must be followed strictly.

Precautions

If any of the following abnormalities occur, pull out the power plug immediately.

- When smoke or any strange odour is emitted.
- When water or any foreign substance enters the interior.
- When dropped or damaged.
- When the power cord is worn.

Switch off the power immediately, then pull out the power plug from the socket. Contact the nearest dealer or service centre. Do not attempt any repairs by yourself.

Do not use with dust or metal particles adhering to the power plug or socket.

- Heat generation or a short circuit can cause fire or an electric shock.
- Pull out the plug and wipe it with a dry cloth every six months.

Insert the power plug into a socket that is easy to plug into and pull out from.

- Make sure that if abnormalities should occur in this unit, the power plug can be pulled out immediately.

Insert the power plug firmly all the way in.

- Heat generation or a short circuit can cause fire or an electric shock.

Keep all plastic bags and other packaging out of the reach of small children.

- Covering over the head with these can cause suffocation.

Do not place in unstable locations.

- If placed on a shaky platform or an incline, or where there is vibration or impact, it can drop or topple over and cause injury.
- This unit cannot be installed vertically.

Do not put anything into the interior.

- If something enters the equipment's interior, it can result in fire or an electric shock.

Do not dismantle/modify.

- The interior has high voltage parts, which can cause fire or an electric shock.

Request an inspection of the interior once a year from the dealer.

- Using with dust accumulated can result in fire.
- Conducting it before the rainy season, where humidity rises, will be more effective.

Do not mishandle batteries as follows.

- Mistaking plus ⊕ and minus ⊖.
- Mixing different types of batteries or those used before.
- Short-circuiting the electrodes.
- Subjecting to heat, dismantling, or putting into water or fire.
- Charging.

Misuse can result in injury or fire due to leakage, heat generation, combustion, cracks, etc.

When not using the remote control for an extended period, remove the batteries.

In the event of leakage, wipe the liquid on the battery case off completely. If the liquid gets onto the body or clothes, rinse it off thoroughly with water.

Avoid sticking your hands into the disc tray.

- It can result in injury. Be careful especially with small children.

Do not place objects in front of the disc tray.

- Placing a cup containing hot water in front of the tray may result in injury or scalds when the tray is opened.

Copyrights

- Recordings from TV broadcasts or pre-recorded material cannot be used without the consent of the right-holder under copyright law, except for personal enjoyment.
- Software or broadcasts containing copyright protection signals cannot be recorded or dubbed.
- Note that broadcasting for profit or public viewing, material recorded/edited using this unit even in miniaturised screens, may infringe on authors' rights protected by copyright law.

Backup of Recorded Contents

- It is advisable to back up discs containing important recordings regularly (every few years). Although digital signals do not deteriorate, failure to play back or record may arise from the effects of aging on the disc depending on its storage environment.
- Recorded data may be corrupted if an outage occurs while this unit is operating. Programmes recorded on the HDD should be dubbed to DVD early as a safeguard against HDD failure.
- Recorded programmes or data cannot be restored once the DVD disc or HDD is damaged.

TRADEMARK AND LICENSE INFORMATION

Manufactured under license from Dolby Laboratories. "Dolby" and the double-D symbol are trademarks of Dolby Laboratories.



"DTS" and "DTS DIGITAL OUT" are trademarks of Digital Theater Systems, Inc.



This product incorporates copyright protection technology that is protected by U.S. patents and other intellectual property rights. Use of this copyright protection technology must be authorized by Macrovision. Reverse engineering or disassembly is prohibited.

GUIDE Plus+, SHOWVIEW, VIDEO Plus+, G-LINK are (1) registered trademarks or trademarks of, (2) manufactured under license from and (3) subject of various international patents and patent applications owned by, or licensed to, Gemstar-TV Guide International, Inc. and/or its related affiliates.



GEMSTAR-TV GUIDE INTERNATIONAL, INC. AND/OR ITS RELATED AFFILIATES ARE NOT IN ANY WAY LIABLE FOR THE ACCURACY OF THE PROGRAM SCHEDULE INFORMATION PROVIDED BY THE GUIDE PLUS+ SYSTEM. IN NO EVENT SHALL GEMSTAR-TV GUIDE INTERNATIONAL, INC. AND/OR ITS RELATED AFFILIATES BE LIABLE FOR ANY AMOUNTS REPRESENTING LOSS OF PROFITS, LOSS OF BUSINESS, OR INDIRECT, SPECIAL, OR CONSEQUENTIAL DAMAGES IN CONNECTION WITH THE PROVISION OR USE OF ANY INFORMATION, EQUIPMENT, OR SERVICES RELATING TO THE GUIDE PLUS+ SYSTEM.

i-LINK is a trademark of Sony Corp.

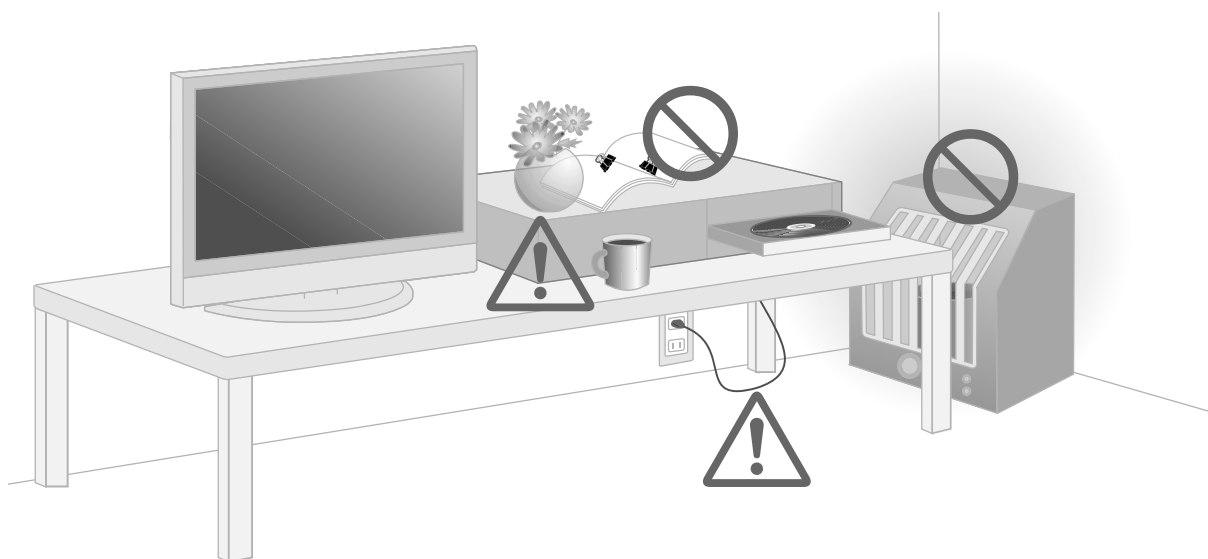

Check Out These Capabilities



Choose a dubbing that matches your purpose

6 ways to dub

HDD ↔ DVD, HDD ↔ VHS, and DVD ↔ VHS dubbing are possible with this single unit.

[P71]

Dub DV tapes

(Equipped with DV input terminal)

Connect with a DV camcorder, and you can dub DV tapes to the HDD/DVD on this unit. [P74]



Even I can programme a timer

Easy programming from the programme listing

(Equipped with programme listing, “The GUIDE Plus+ System”)

Programme easily from the programme listing on the TV screen. [P46]

Countries that can receive the programme listing are Austria, Belgium, France, Germany, the Netherlands, Spain, Switzerland, Italy, the United Kingdom, and Luxembourg.

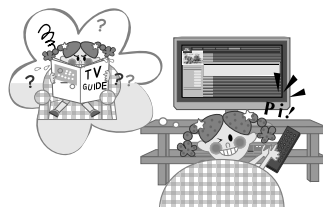

Doing this and that is a breeze!



Dub to VHS tapes with ease

Dub an entire VHS tape exactly to a DVD disc

(One-Touch Expert Dubbing)

Dub an entire VHS tape with recordings to a DVD disc simply by pressing the button on the unit. [📖 P79]

Record copy-once programmes on DVD-R

Supports DVD-R (VR mode) recording. [📖 P69]



Even I can play back

Record and play back using DVD-RAM/-RW/-R discs

(Equipped with DVD Multi Drive)

Choose from DVD-RAM, DVD-RW and DVD-R discs to match your purpose. [📖 P12]

Play a variety of discs

(Super Multi Playback)

In addition to DVD-RAM, DVD-RW and DVD-R, +RW and +R discs are also playable. [📖 P12]

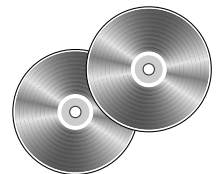

Common Ways to Use

Recommended ways of using this unit!

Start off by recording to the HDD

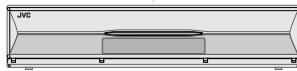
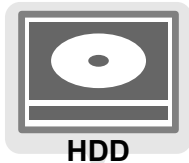

“Basic Recording (HDD/DVD)”
[P38]
“Timer Programming Using
Programme Listing (The
GUIDE Plus+ System)” [P46]



Fully recordable
Max. 300 hours
(with recording mode at
FR480) [P92]

Delete unwanted programmes watched



“Deleting/Protecting a
Programme” [P88]

To cut away excess portions or commercials

“Deleting Scenes” [P89]

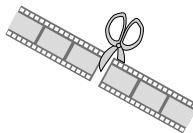

To transfer VHS tape contents to DVD discs



“Just Dubbing from VHS to
DVD” [P79]

To watch only favourite scenes

“Gathering Favourite Scenes (Play List Creation)” [P84]

Dub to DVD discs for long-term storage

“Dubbing” [P68]
“Dubbing between HDD and DVD Deck” [P72]



Which discs to use?

“About Discs” [P12]

How much can be recorded onto one disc?







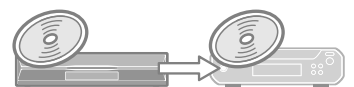

“Recording Mode” [P92]

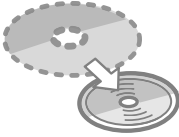
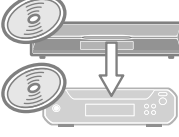
To watch on other DVD players

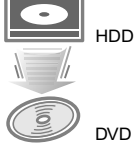
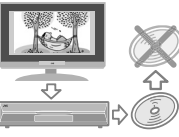
“Watching on Other DVD Players (Finalising)” [P67]



How to choose a DVD disc

At times like these	Usable DVD discs		
To record repeatedly 	DVD-RAM <i>Approx. 100K times</i>	DVD-RW <i>Approx. 1000 times</i>	
To play on other units 	Recording on DVD-R (Video mode) is recommended. • Be sure to finalise after recording. [P67]		DVD-R (Video mode) 
To perform high speed dubbing from the HDD 	DVD-RAM <i>Max. approx. 3x speed</i>	DVD-RW <i>Max. approx. 4x speed</i>	DVD-R <i>Max. approx. 8x speed</i>
To record programmes that are only recordable once 	CPRM-compliant DVD-RAM 	CPRM-compliant DVD-RW (VR mode) 	CPRM-compliant DVD-R (VR mode)  (Formatting [P66])
Not sure which disc to use 	DVD-RAM 	DVD-RAM is recommended. • Does not require formatting. • Able to record repeatedly, or edit such as deleting unwanted parts.	

For details on the types of discs, see “About Discs” [P12].

When using DVD-RW, DVD-R

Formatting is necessary. [P66]

With DVD-RW

- Format in either VR mode or Video mode.
- Able to format as many times as desired.

With DVD-R

- Format using new discs only for VR mode.
- It will be in Video mode when not formatted.
- Unable to reformat.

VR mode

- When you wish to record repeatedly or edit such as deleting unwanted parts. (Unable to record repeatedly with DVD-R.)
- Deleting recorded programmes will increase the disc remaining time. (Does not increase for DVD-R.)
- When you wish to record programmes that are only recordable once. (Use a CPRM-compliant disc.)

Video mode

- When you wish to play back on other DVD players.
- Unable to edit such as deleting unwanted parts.
- Deleting recorded programmes will not increase the disc remaining time.

Contents

DR-MX10SE
VHS & HDD & DVD VIDEO RECORDER



Getting Started	2
Safety Precautions.....	2
Precautions during Operation.....	3
Precautions.....	4
Copyrights.....	5
Check Out These Capabilities.....	6
Common Ways to Use.....	8
Contents.....	10
About Discs.....	12
Recordable/Playable Discs.....	12
Discs for Playback Only.....	12
Unplayable Discs.....	13
Care of Discs.....	13
Handling of Discs.....	13
Cartridge-enclosed DVD-RAM.....	13
Caution for DualDisc Playback.....	13
Disc Storage.....	13
When the Recording/Playback Lens is Dirty.....	13
About VHS Tapes.....	14
To View a Clear Picture (Cleaning Tape).....	14
VHS Tapes.....	14
Loading the VHS Tape.....	14
How to Use this Manual.....	15
About this Manual.....	15
Operation of the Menu Screen.....	15
Functions of Each Part.....	16
Remote Control.....	17

Preparations	18
Selecting Devices to Connect.....	18
Receiving via Antenna.....	19
Receiving via External Receiver.....	20
Connect Using SCART Cable.....	20
Connect Using Component Video Cable.....	21
Dubbing from DV Camcorder/ Video Cassette Recorder.....	22
Listening with Digital Audio (Theatre Surround).....	22
Setup Procedures.....	23
Auto Setup.....	24
Preset Download.....	26
Setting On-screen Language.....	27
Setting TV Screen Size.....	28
Input/Output Setting.....	29
The GUIDE Plus+ System Setup.....	30
The GUIDE Plus+ System.....	32
Operation of Remote Control Buttons.....	32
Screen Layout of the GUIDE Plus+ System.....	32
Types of Area.....	33
Editor Area.....	33
Clock Setting.....	34
SHOWVIEW Guide Channel Set.....	35
Setting Receiving Channels.....	36

Basic Operations	38
Basic Recording (HDD/DVD).....	38
Basic Recording (VHS).....	40
Basic Playback (Library Database Navigation).....	42
Usable Buttons during Playback (HDD/DVD).....	44
Timer Programming Guide.....	45
Timer Programming Using Programme Listing (The GUIDE Plus+ System).....	46
Timer Programming Using SHOWVIEW Number in the Programme Listing.....	47

Useful Functions of the Programme Listing.....	47
Manual Timer Programming	
(The GUIDE Plus+ System)	48
Searching Programmes for Timer Programming	
(The GUIDE Plus+ System)	50
To Search by Keyword	51
Using the "My TV" Area	51
SHOWVIEW Timer Programming	52
Calendar Timer Programming	54
Changing or Cancelling a Timer Programme	
(The GUIDE Plus+ System)	56
Checking, Changing or Cancelling a	
Timer Programme	57
Playing VHS Tapes	58
Watching While Recording	60
Programme Playback during Recording	
(HDD & DVD-RAM)	60
Play Back Other Programmes While Recording	
(HDD, DVD-RAM/RW-R & VHS).....	61
Watching DVD Videos	62
Watching DVD Videos.....	62
Audio, Subtitle and Angle Selection	63
Progressive Scan Output	64
Enabling Progressive Scan Output	64
Disabling Progressive Scan	64
Playing Back MP3 & JPEG Files	65
Formatting	66
Watching on Other DVD Players (Finalising)	67

Dubbing **68**

Dubbing	68
Recordable Once Only Programmes (Copy-once)	69
Types of Dubbing	70
Dubbing between HDD and DVD Deck	72
Dubbing from DV Camcorder/	
Video Cassette Recorder	74
Dubbing from DV Camcorder	74
Dubbing from Video Cassette Recorder (VCR)	75
Dubbing from HDD or DVD to VHS	76
Dubbing from VHS to HDD or DVD (Entire)	77
Dubbing from VHS to HDD or DVD (1 Programme)	78
Just Dubbing from VHS to DVD	79

Editing **80**

Modifying Thumbnail/Category	80
Modify Thumbnail.....	81
Modify Category.....	81
Creating Programme Title	82
Creating/Deleting Chapters (Marks)	83
Gathering Favourite Scenes (Play List Creation)	84

Editing Play List	86
Modify Scene	86
Move Scenes.....	87
Add Scenes	87
Deleting/Protecting a Programme	88
Deleting a Programme	88
Deleting Scenes	89
Dividing Scenes	90

Useful Features **91**

Help Guide	91
Recording Mode	92
FR (Free Rate) Mode.....	92
DV Mode.....	93
Weekly/Daily Timer Programming	94
Temporary Recording	96
Setting Time Range for Temporary Recording.....	96
Using the Temporary Recording Function	96
Timer Recording	97
Managing DVDs (Library)	98
To Register to Library	98
To Delete from Library	98
To Search for Recorded Programmes from Library.....	98
Recording with Best Picture Quality (VHS)	99
Sound	100
Manual Tracking/Tape Remaining Time (VHS)	102
To Adjust Tracking Manually	102
To Check the Remaining Time on a VHS Tape	102
Avoiding Misuse	103
To Disable Operation (Child Lock).....	103
To Lock the Disc Tray (Tray Lock)	103
Changing Remote Control Settings	104
Operating a TV from Other Manufacturers	104
Using Multiple JVC Recorders	104
Screen Display	105
On-Screen Display	105
Playback Setting Menu Operations	106
How to Use the Playback Setting Menu	106
Description of Each Setting	107
Setup Menu	109
TV Station and ID List	116
Language Code List	117

Troubleshooting/Appendix **118**

Q&A	118
Troubleshooting	120
On-screen Message	122
Specifications	124
Glossary	125
List of Terms	126

Verify the Accessories

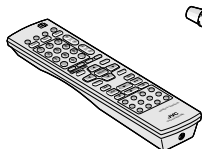

Infrared remote control unit

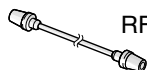

RF cable



21-pin SCART cable







R6 Battery x 2



IR blaster (G-LINK)









About Discs

Recordable/Playable Discs

Disc type		Recording mode	Formatting	Repeated recording	Live Memory Playback	Editing	Finalising
HDD 	Built-in			✓	✓	✓	
DVD-RAM 	12 cm: 4.7 GB/9.4 GB (*1) 8 cm: 1.4 GB/2.8 GB (*1) Ver. 2.0 Ver. 2.1 Ver. 2.1/3x	VR mode	✓	✓	✓	✓	
DVD-RW 	12 cm: 4.7 GB 8 cm: 1.4 GB Ver. 1.1 Ver. 1.1/2x Ver. 1.2/4x	VR mode	✓	✓		✓	✓
		Video mode	✓	✓			✓
DVD-R 	12 cm: 4.7 GB 8 cm: 1.4 GB General Ver. 2.0 Ver. 2.0/4x/8x Ver. 2.1/16x	VR mode	✓			✓	✓
		Video mode					✓

*1 The 9.4 GB and 2.8 GB DVD-RAM discs stated in the table refers to double-sided discs, not double-layered discs.

Discs for Playback Only

Disc type	Description
DVD Video 	Commercially available video disc (e.g. movies, music) The region number playable on this unit is "2".  (example of playable region number indications) Converts discs in TV formats other than PAL format (e.g. NTSC format), to PAL format for playback.
DVD Audio 	Commercially available music DVD Discs marked as playable with DVD player can be played.
Video CD  Super Video CD 	Commercially available video disc
CD-DA 	Music CD DTS music CDs can also be played. (Decoder required separately.)
CD-ROM 	MP3 and JPEG files in music CD format as well as "ISO9660" or Joliet format can be played.
CD-R/ RW  	JPEG files playable on this unit must conform to JFIF/Baseline process, and the maximum resolution is 2,812 pixels in width by 2,112 pixels in height. (Includes CD-R or CD-RW recorded in Video CD/Super Video CD format.)

- +R/+RW discs recorded and finalised in Video mode can be played. "DVD" will be displayed on the front display panel.
- CDs recorded in Packet Write format cannot be played.
- The performance of CDs that do not conform to CD-DA standards (e.g. copy control CDs) cannot be guaranteed.

Unplayable Discs

- DVD-RAM (2.6 GB/5.2 GB)
- DVD-R DL (single-sided double-layered)
- +R DL (single-sided double-layered)
- DVD-R for Authoring
- CD-ROM/R/RW (including PhotoCD, CD-G)
- DDCD (1.3 GB Double Density CD)
- HDCD (High Density CD)

Never use discs with their seals or labels peeled off; discs in unusual shapes rather than circular ones; badly warped discs; cracked discs and others.

Care of Discs

- Dirt such as fingerprints or dust on the disc may result in distortions in images or sounds. Always keep clean with a soft cloth.
- Gently wipe from the centre of the disc towards the edge with a soft cloth.
- For stubborn stains, wipe using a cloth dampened with a little water, then finish with a dry cloth.
- Never use thinner or benzene, alcohol, conventional record cleaners or anti-static sprays. It may damage the disc.

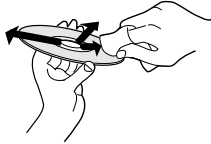

Handling of Discs

Removing the disc

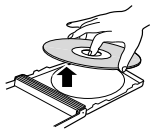

Placing the disc

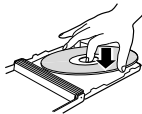

Correct way to hold the disc



- Avoid touching the recording/playback surface.

Cartridge-enclosed DVD-RAM

- Cartridge-enclosed DVD-RAM is not supported. Remove the disc from its cartridge before use. For details on removable discs (TYPE2, TYPE4), refer to their manuals.

Caution for DualDisc Playback

The non-DVD side of a DualDisc does not comply with the Compact Disc Digital Audio standard. Therefore, the use of non-DVD side of a DualDisc on this unit is not recommended.

Disc Storage

- Avoid storing in the following places.
 - Humid or dusty places and places prone to fungus.
 - Places exposed to direct sunlight or near heaters.
 - Inside a vehicle in summer.
- Do not drop or subject to impact.
- Put into the case and store upright.
- Stacking, propping or dropping without putting it in a case may result in deformation and cracks.

When the Recording/Playback Lens is Dirty

- Extended use may lead to dust or dirt adhering to the recording/playback lens and preventing normal recording or playback.
- Cleaning with a commercially available DVD lens cleaner every six months is recommended, although it also depends on the frequency of use and the installation environment.
- Refer to the lens cleaner manual on how to clean.

About VHS Tapes

To View a Clear Picture (Cleaning Tape)

Causes of the heads getting dirty

- High temperature or humidity (rainy season, etc.)
- Dust in the air



- Damage to or dirt on the tape
- Prolonged use, etc.
- Mouldy tape

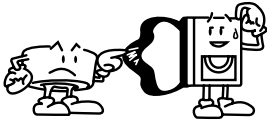

When this happens

- Noise appears in the picture if the tape is played.
- The picture is fuzzy, or does not appear.

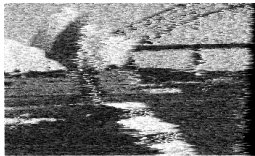

At times like this

- Use a dry cleaning cassette to clean the video heads.

If unable to obtain a normal picture even after using a cleaning cassette

- Consult your dealer, or a nearby JVC service centre.

VHS Tapes

- Use **S-VHS** and **VHS** tapes. However, S-VHS recordings are not possible.
- When recording on pre-recorded tapes, previous recordings will be erased.
- VHS tapes cannot be used upside down.
- Do not open the VHS tape's cover, dismantle it, or touch the tape inside.
- Do not eject and load the tape repeatedly without running it. It may damage the tape.
- Rewind the tape fully after use.

SQP (S-VHS Quasi Playback) function

- Tapes recorded in S-VHS format can also be played. However, it will not be of the original S-VHS high image quality.

To prevent accidental erasure

- If you wish to avoid erasing important recordings by mistake, break off the record safety tab. Cover the hole with adhesive tape twice to enable recording again.

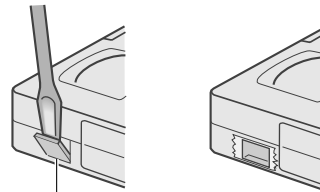

Record safety tab

Loading the VHS Tape

- Do not stick your hand into the tape slot. Your hand may get stuck and injured.

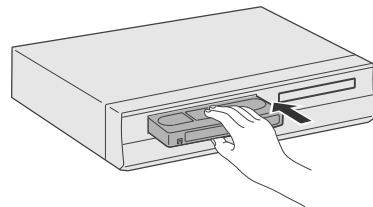

With the window side facing up, push the tape in slowly at the midportion.

- To record, load a tape with the record safety tab intact.

How to Use this Manual



- Applicable media are highlighted on the above icons.

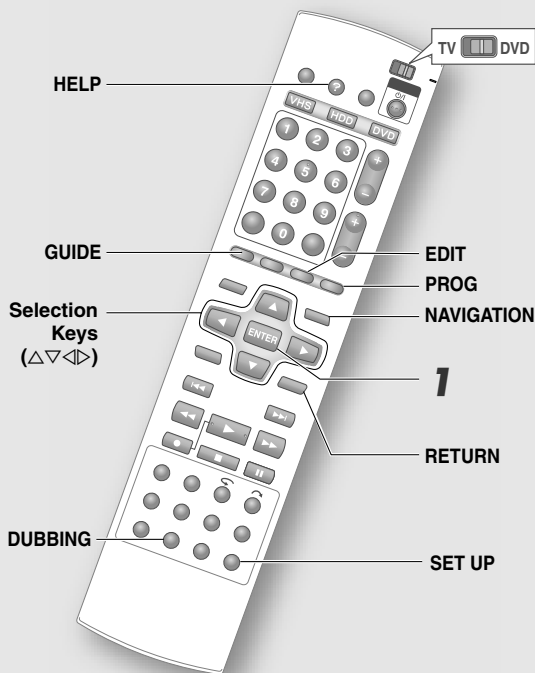

- Buttons to use in each step are denoted by step numbers.
- Other buttons to use are denoted by button names.

About this Manual

The text in this manual mainly describes operations that use the remote control.

- Remote control buttons are expressed as button names.
- Options on the menu screen are enclosed in double inverted commas as in "option".

Supplementary descriptions in this manual.

- **NOTE:** Describes relevant information.
- **IMPORTANT:** Describes limitations on functions or operation.
- **CAUTION:** Indicates a cause of malfunction or the possibility of recordings being erased.
- : Denotes the relevant page.
- **01 - 41**: Numbers attached to items in the setup menu.

Operation of the Menu Screen

- The menu screen will be displayed when any of the following buttons is pressed.

SET UP, GUIDE, NAVIGATION, EDIT, PROG, DUBBING, HELP

- Select options using the **Selection Keys** (Δ▽◀▶) on the remote control.

SELECT

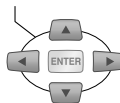

- Option

A light green item with a small arrow, on the menu screen. However, it is not light green in colour in the GUIDE Plus+ system.

- Confirm using **ENTER**.

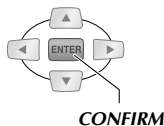

Example

1 Select an item.

SELECT

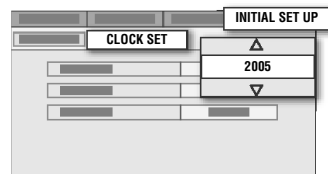
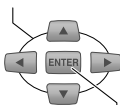

CONFIRM

- Options are prominently shown as pop-ups in the screen illustration on this manual.
- Press **RETURN** to return to the previous menu screen or the broadcast screen.
- Simple operations are displayed on the left or bottom in most menu screens.

(Bottom screen display)

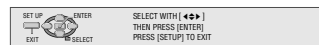

- Verify the settings, then press the initial button again to exit the menu screen and return to the broadcast screen.

Functions of Each Part

Front View

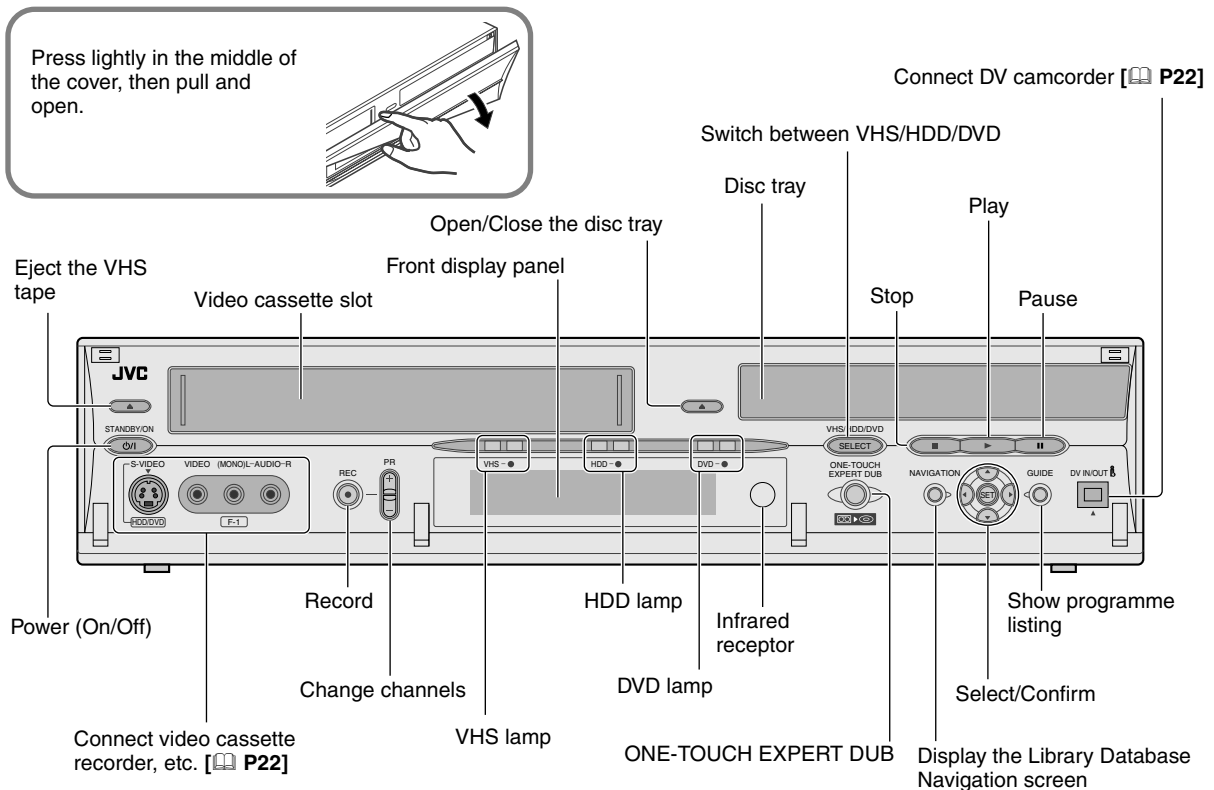

Front display panel

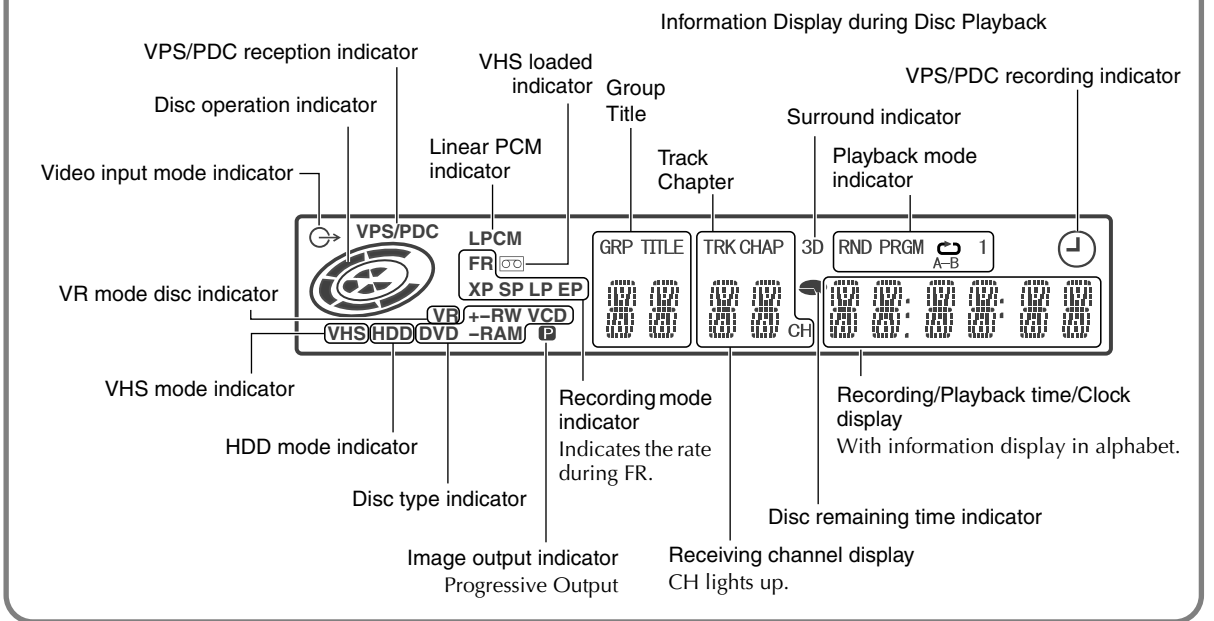

- There are 2 levels of brightness that can be set for the front display panel. **Setup Menu** “DIMMER (DURING POWER ON)” [P113] 30
- Messages may be displayed depending on the operation.
 - When the power plug is inserted: Alternating display of “PLEASE” and “WAIT”.
 - When a disc is loaded: “READING”

Remote Control

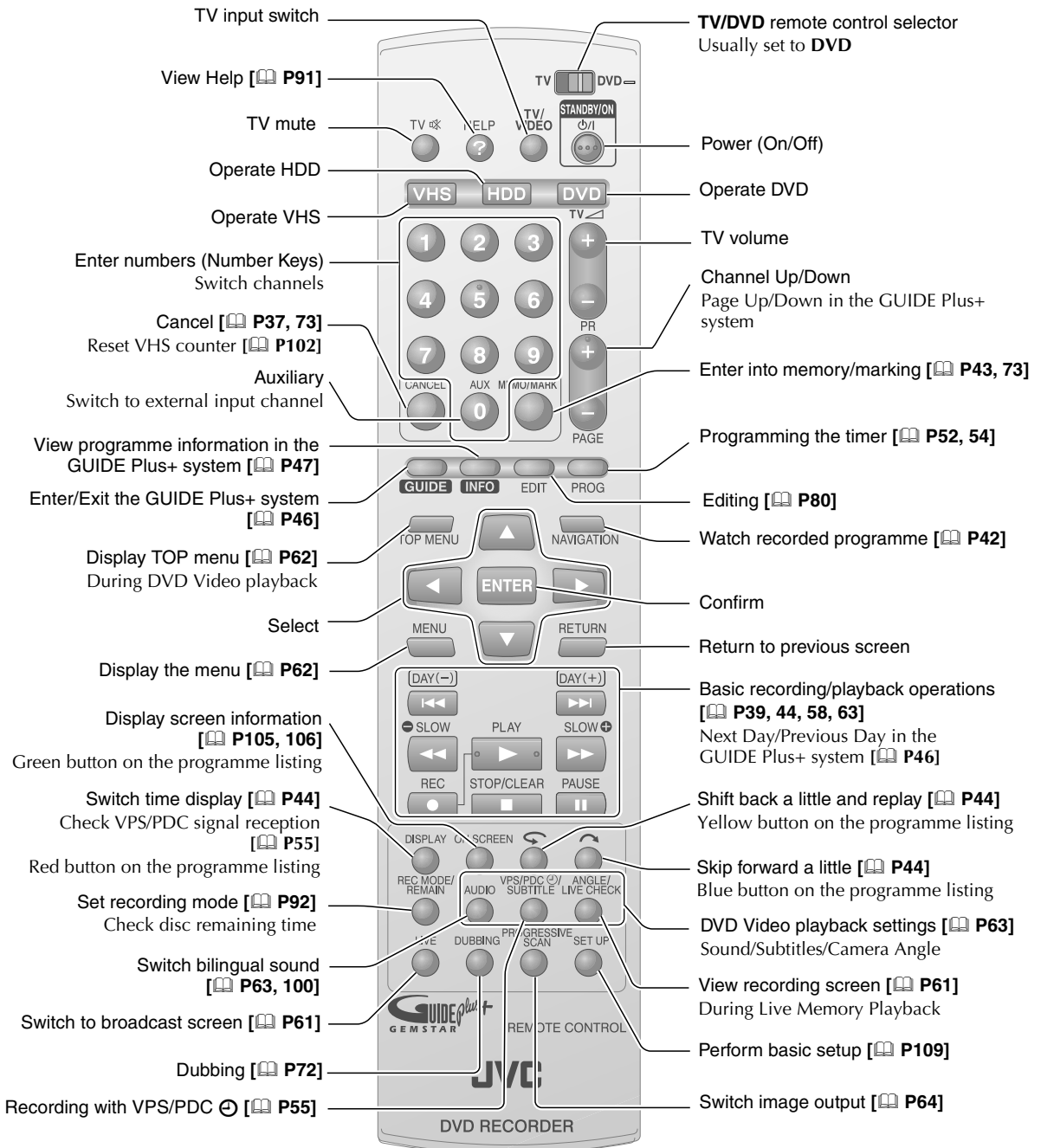

NOTES: (Regarding batteries)

- If the remote control's functional distance becomes shorter, the batteries are depleted. At times like this, replace with new batteries. Insert them correctly in the directions indicated for ⊕ and ⊖.
- If problems occur while using the remote control, remove the batteries, then re-insert them after more than 5 minutes and try again.

Selecting Devices to Connect

- ▶ Connection methods vary with the devices used. Refer also to the manuals of the devices to be connected.
- ▶ Turn off the devices before connecting.

Install if using the GUIDE Plus+ system via external receiver.

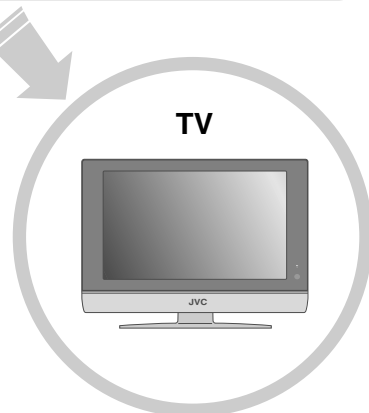
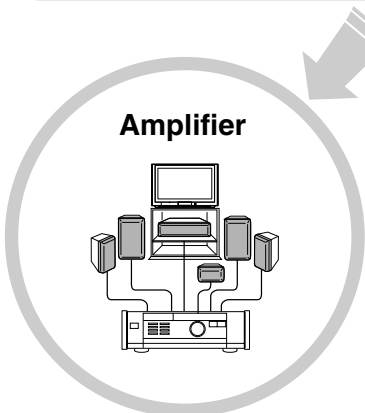
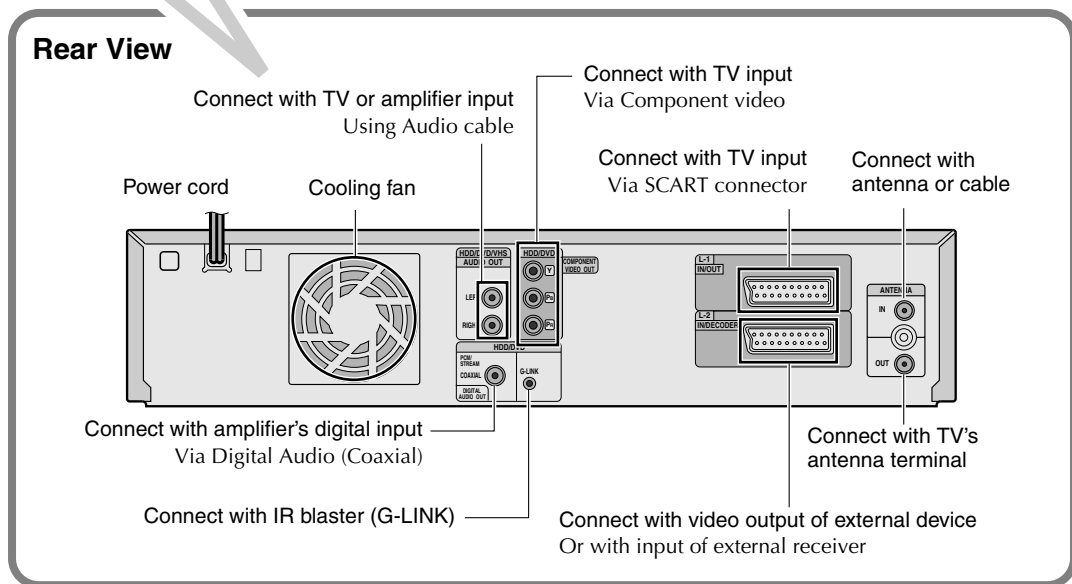
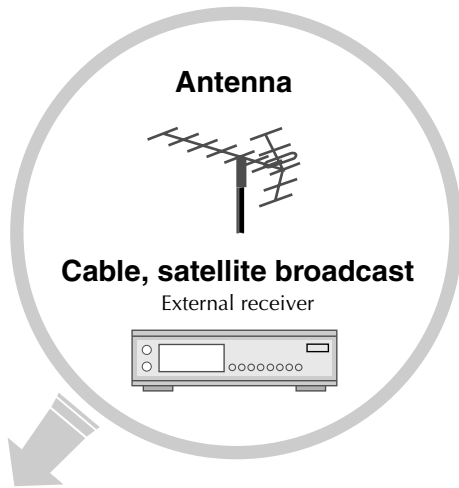
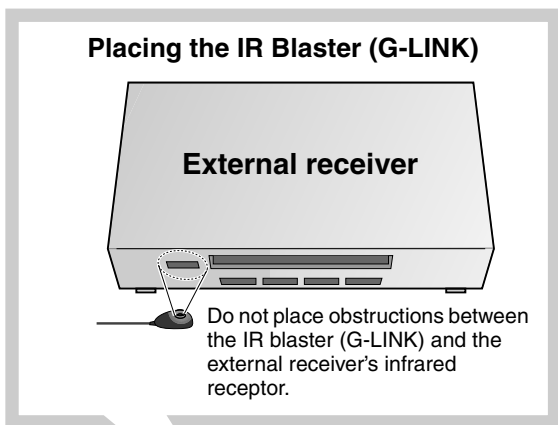

Receiving via Antenna

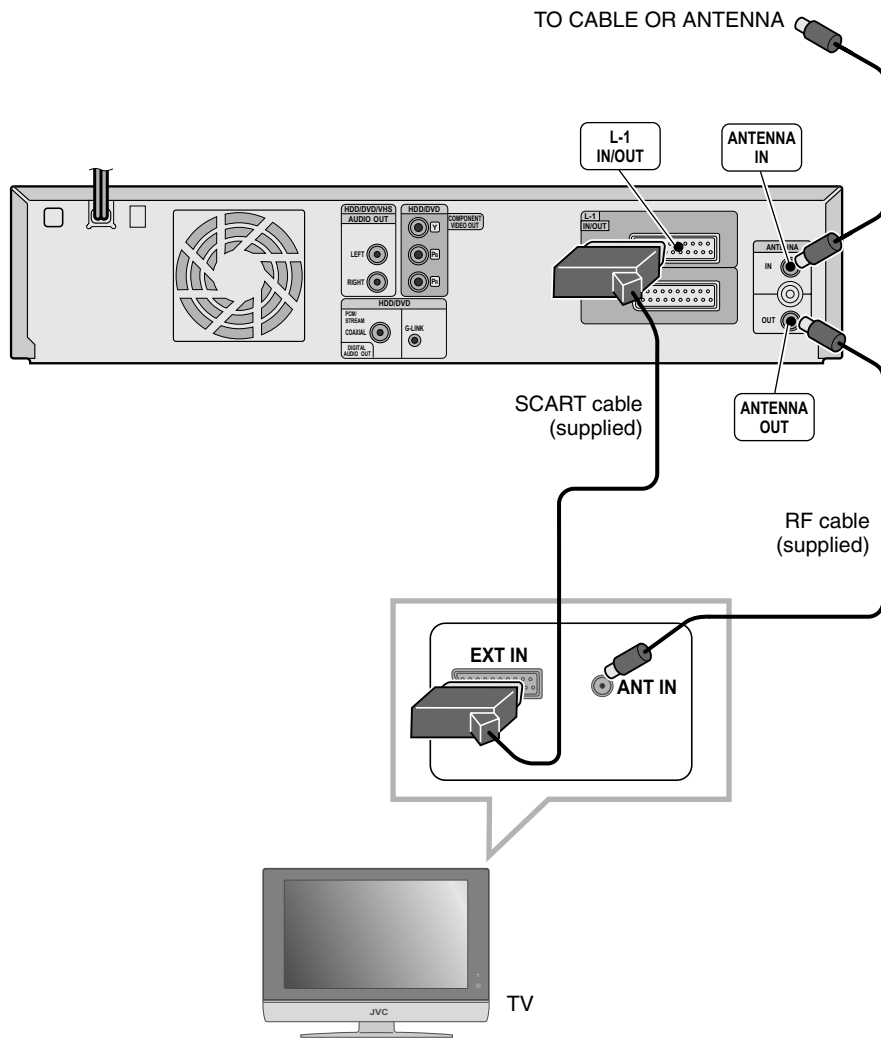

Connect Using Component Video Cable

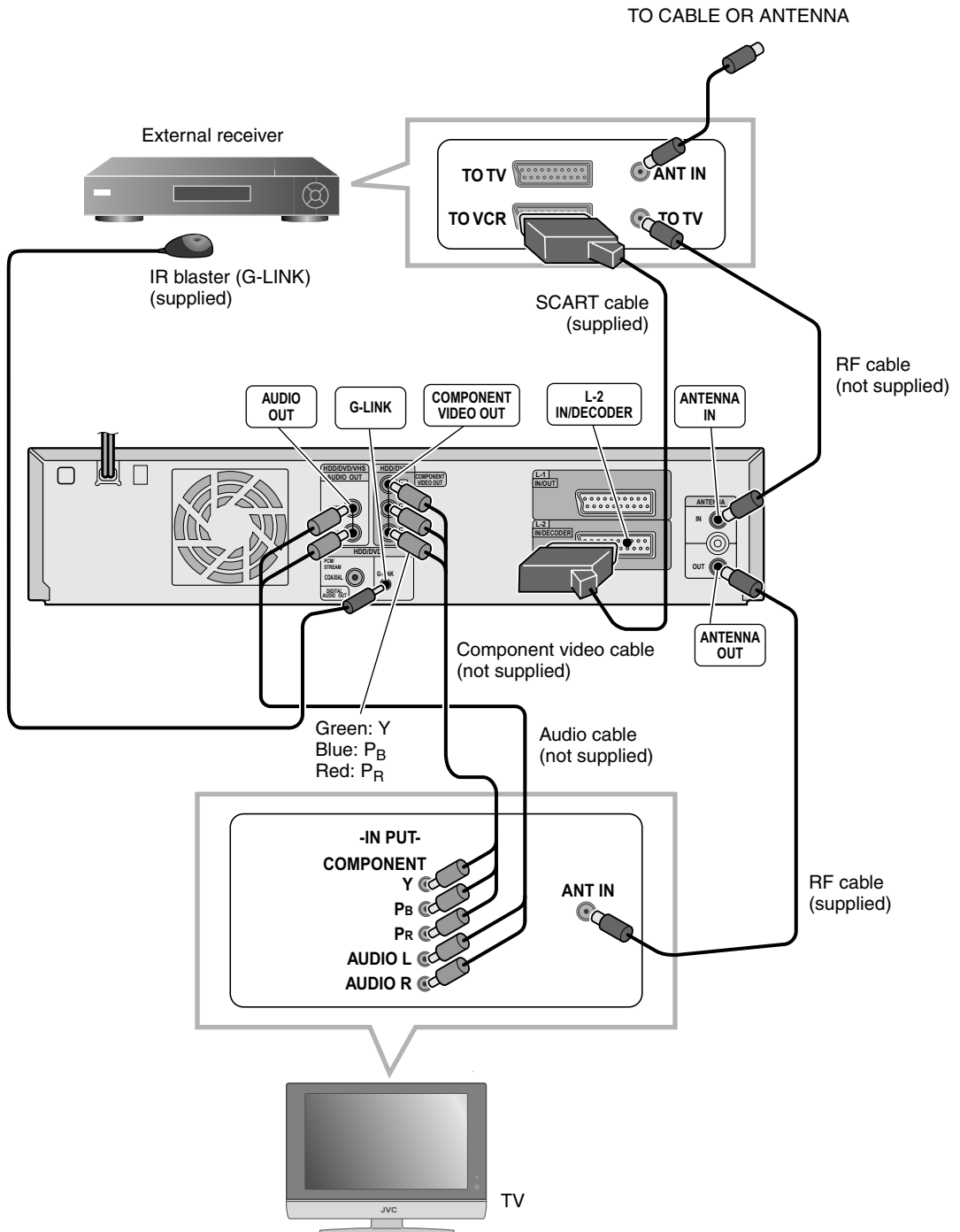

IMPORTANT:

- To use the component output, be sure to set the following. **Setup Menu** "L-1 OUTPUT" = "COMPONENT"
 [P114] 36
 Otherwise, the proper image will not be displayed.
- Leave the external receiver on during timer recording standby.

Dubbing from DV Camcorder/Video Cassette Recorder

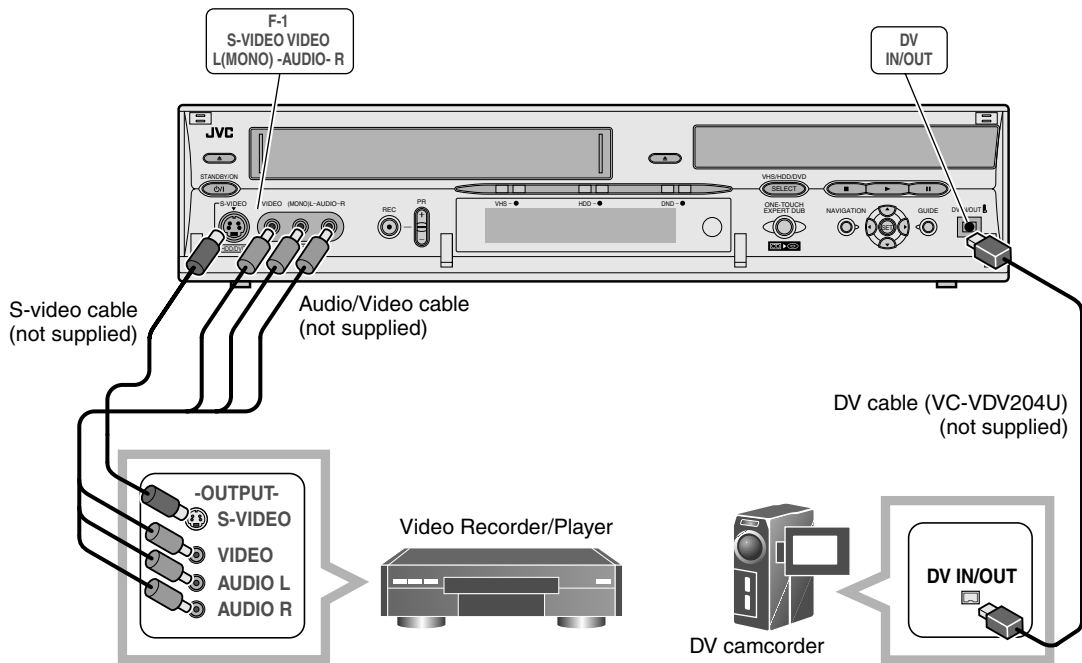

IMPORTANT:

- When connecting the unit to a device equipped with a DV input connector, be sure to use the optional DV cable (VC-VDV204U).

NOTE:

- The [DV IN/OUT] terminal works bidirectionally.

Listening with Digital Audio (Theatre Surround)

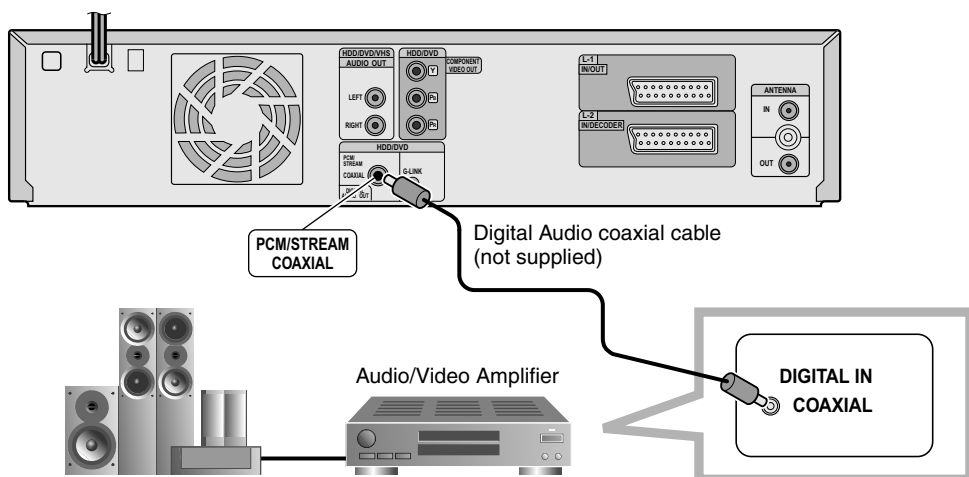

IMPORTANT:

- See "Sound" [P100].
- It is not possible to switch the audio for bilingual programmes recorded on DVD-RAM, DVD-RW (VR mode) or DVD-R (VR mode). In such cases, set the following. **Setup Menu** "DIGITAL AUDIO OUT" = "PCM ONLY" [P110] [04].

Setup Procedures

► In order to use this unit correctly, set each item in the following steps.

When connecting an antenna and TV,

- 1 Turn on the TV.**
- 2 Switch the TV to the input (EXT-1, EXT-2, etc.) connected with this unit.**
- 3 Insert the unit's power plug into the socket.**
 - "PLEASE" and "WAIT" blink alternately on the front display panel as the unit starts up. (Takes around 40 seconds.)
- 4 When "PLEASE" and "WAIT" go off, turn on the unit.**
 - Auto setup begins automatically, and the country select screen is displayed.
- 5 Select your country.**

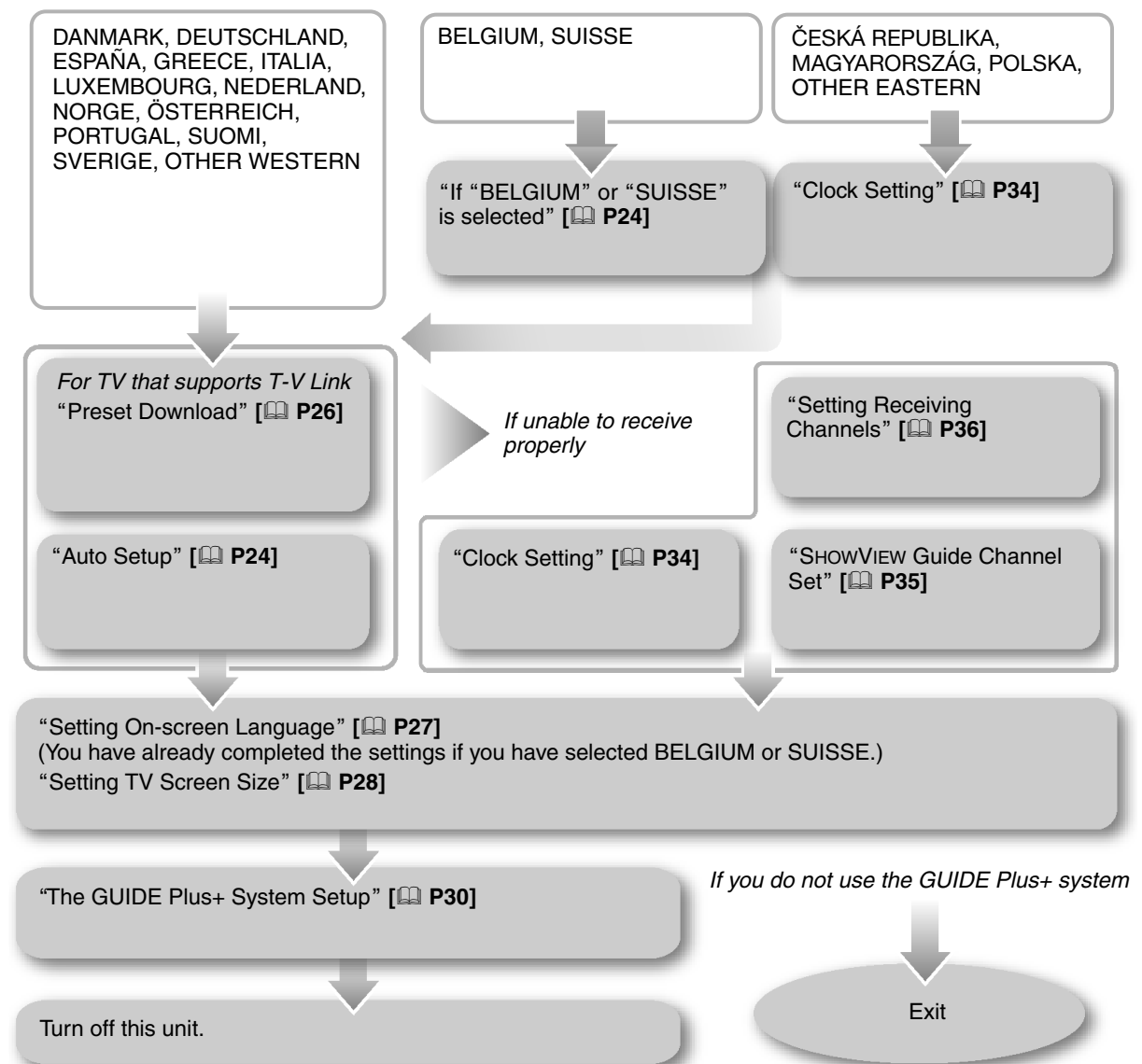

Auto Setup

- ▶ Auto setup is a function to easily set this unit's receiving channel, clock and guide programme number by selecting the region.

PREPARATION:

- Switch TV/DVD on the remote control to DVD.

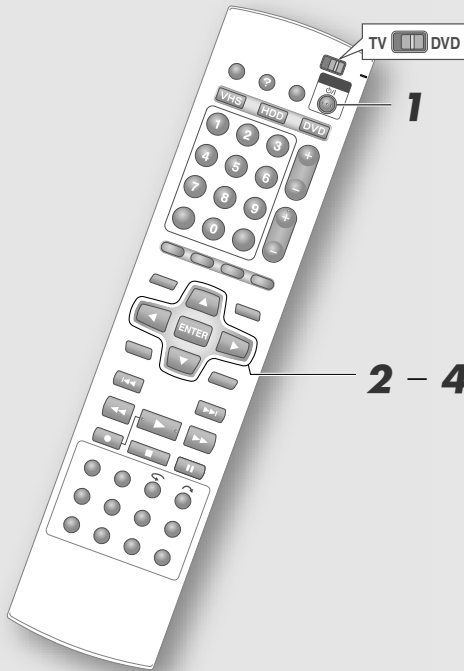

IMPORTANT:

- In areas where the PDC (Programme Delivery Control) signals are not transmitted, the clock and guide programme number cannot be automatically set.

1 Turn on the unit.

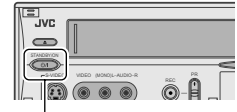

STANDBY/ON

- To turn on using the unit, press **STANDBY/ON**.
- The area selection screen will be displayed automatically.

2 Select your country name.

SELECT

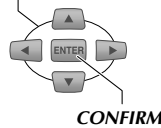

- If "DANMARK", "NORGE", "SVERIGE", or "SUOMI" is selected, the GUIDE Plus+ system screen will be set to "ENGLISH".
When the confirmation screen is displayed, press **ENTER**.

If "BELGIUM" or "SUISSE" is selected

1 Select a language.

SELECT

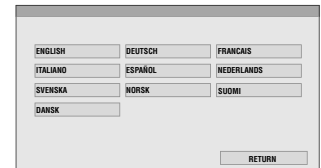
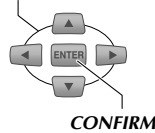

- If "DANSK", "SUOMI", "SVENSKA", or "NORSK" is selected, the GUIDE Plus+ system screen will be set to "ENGLISH".
When the confirmation screen is displayed, press **ENTER**.

If "MAGYARORSZÁG", "ČESKÁ REPUBLIKA", "POLSKA", or "OTHER EASTERN" is selected

1 Set the clock.

- See "Clock Setting" [📖 P34].

3 Select "AUTO SET".

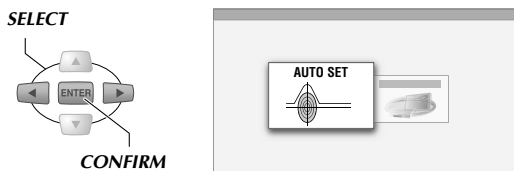

- The AUTO SET screen will be displayed, and auto setup is performed.

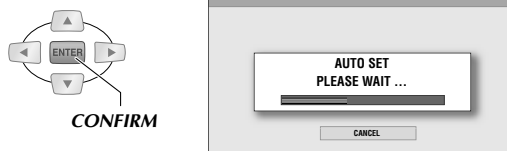

- While AUTO SET is in progress, "AUTO" will be displayed on the front display panel. Do NOT press any button on the unit or the remote control during this time. To cancel, press **ENTER**.

The "SCAN COMPLETED" screen will be displayed when AUTO SET is completed.

4 Exit setup.

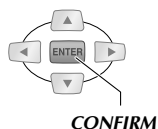

If auto setup was successful

The channel and correct time will be displayed on the front display panel.

PR 1 20:00

- If SHOWVIEW timer programming is performed, the guide programme number can be verified. See "SHOWVIEW Timer Programming" [P52].

IMPORTANT:

- After auto setup, check the channels that were set. If the same broadcast station was set to multiple channels, delete the ones with poor reception. If the same broadcast station was set to multiple channels, the programme listing may not be displayed properly.

If auto setup was unsuccessful

The clock display on the front display panel will be "--:--". The channel may also not be displayed.

PR 1 --:--

- Check the antenna cable connection, switch off the power, then perform auto setup all over again.
- Set channels manually for broadcast stations with poor reception. See "Setting Receiving Channels" [P36].

■ Onscreen language settings by countries

If the country name is set, the onscreen language will be set automatically as shown below.

Country name	Language
SUOMI	→ SUOMI
PORTUGAL	→ ENGLISH
DEUTSCHLAND	→ DEUTSCH
POLSKA	→ ENGLISH
NORGE	→ NORSK
SVERIGE	→ SVENSKA
DANMARK	→ DANSK
ÖSTERREICH	→ DEUTSCH
ČESKÁ REPUBLIKA	→ ENGLISH
ITALIA	→ ITALIANO
MAGYARORSZÁG	→ ENGLISH
ESPAÑA	→ ESPAÑOL
NEDERLAND	→ NEDERLANDS
GREECE	→ ENGLISH
LUXEMBOURG	→ ENGLISH
OTHER WESTERN	→ ENGLISH
OTHER EASTERN	→ ENGLISH

- For "BELGIUM" and "SUISSE", the language will not be set automatically.
- Onscreen languages can be reset to other languages. See "Setting On-screen Language" [P27].
- If "DANMARK", "NORGE", "SVERIGE", or "SUOMI" is selected, the GUIDE Plus+ system screen will be set to "ENGLISH".

Preset Download

- ▶ If using a TV that provides the T-V Link function, channel settings can be downloaded from the TV by connecting with a SCART cable.

PREPARATION:

- Switch **TV/DVD** on the remote control to **DVD**.

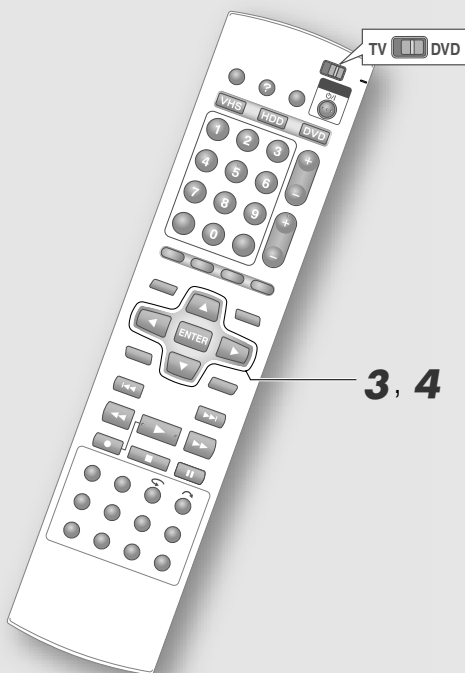

IMPORTANT:

- Check that the SCART cable to use is fully wired.

NOTE:

- Settings can also be made from **Setup Menu** “INITIAL SET UP” → “TUNER SET” → “AUTO SET”.

Perform step **1 – 2** [📖 P24] of “Auto Setup”.

3 Select “T-V LINK”.

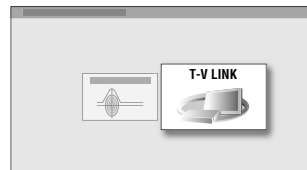
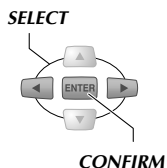

- The “T-V LINK” screen will be displayed, and auto setup is performed.

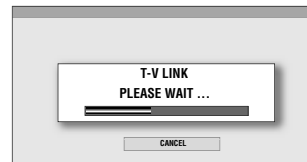
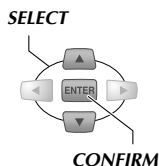

The “SCAN COMPLETED” screen will be displayed when T-V LINK is completed.

4 Exit setup.

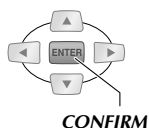

T-V Link functions

Other than the downloading of settings, the following can also be done.

TV Auto Power On

If the play button on this unit is pressed, the TV will be turned on and be switched to the input connected with this unit.

Unit Auto Standby

You can use your TV's remote control to turn off this unit.

Direct Rec

Channels being watched on TV can be recorded instantly.

See “DIRECT REC” [📖 P39].

- Refer also to the TV manual for details on T-V Link.
- There are systems such as EasyLink, Megalogic, SMARTLINK, Q-Link, and DATA LOGIC with similar functions. The compatibility and available functions may differ by system.

Setting On-screen Language

- ▶ Set the language for menu display on the screen.

PREPARATION:

- Switch TV/DVD on the remote control to DVD.

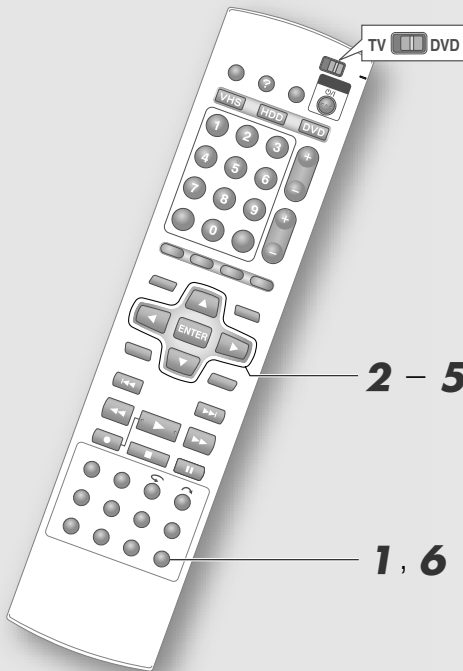

IMPORTANT:

- If "DANSK", "SUOMI", "SVENSKA", or "NORSK" is selected, the GUIDE Plus+ system screen will be set to "ENGLISH".

1 Access the setup menu.



2 Select "FUNCTION SET UP".

3 Select "DISPLAY SET".

SELECT

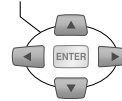

4 Select "ON SCREEN LANGUAGE".

SELECT

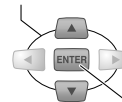

CONFIRM

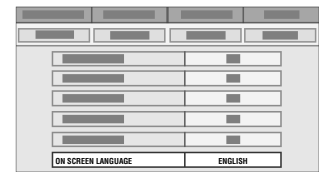

5 Select the desired language.

SELECT

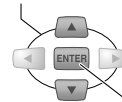

CONFIRM

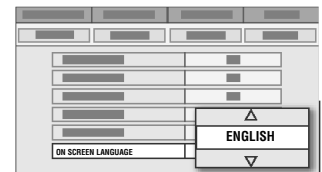

6 Exit setup.



Setting TV Screen Size

- ▶ Set in accordance with the monitor type of the connected TV and others.

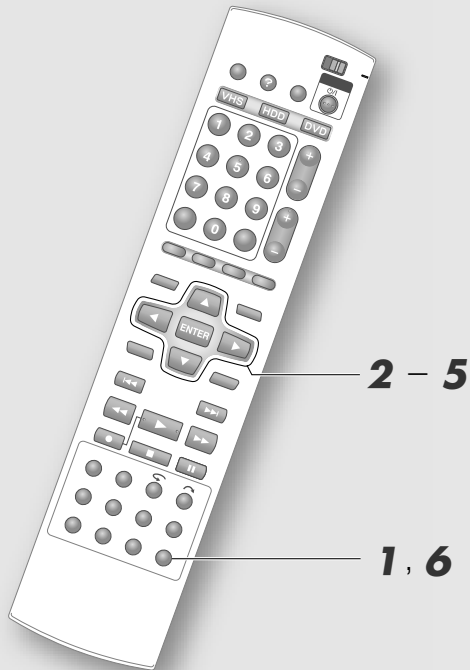

MONITOR TYPE

“4:3LB” (Letterbox conversion)

Select this if the aspect ratio of your TV is 4:3 (conventional TV). When displaying a 16:9 wide image, it is displayed in full screen with a black band at the top and bottom.

“4:3PS” (Pan & Scan)

Select this if the aspect ratio of your TV is 4:3 (conventional TV). When displaying a wide image, it is displayed with the left and right cropped.

“16:9AUTO” (Wide television conversion)

Select this if the aspect ratio of your TV is 16:9 (wide TV). When displaying a 4:3 image, the TV will adjust accordingly.

“16:9FIX” (Wide television conversion)

Select this if the aspect ratio of your TV is 16:9 (wide TV). When displaying a 4:3 image, this unit will adjust accordingly.

1 Access the setup menu.



2 Select “FUNCTION SET UP”.

3 Select “VIDEO IN/OUT”.



4 Select “MONITOR TYPE”.

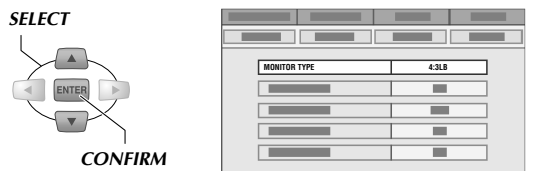

5 Select the monitor type of your TV.

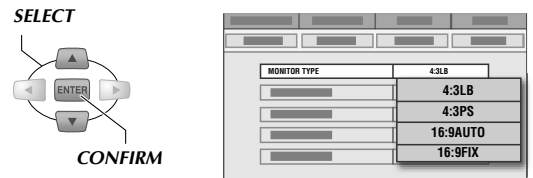

6 Exit setup.



Input/Output Setting

- ▶ The SCART connector supports the connection of composite video signals. Settings must correspond with the type of video signal to use and the device to connect.

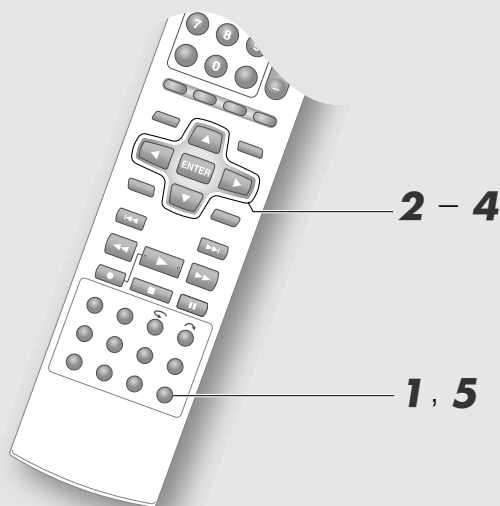

IMPORTANT:

- For normal use, you can leave the default settings as they are.
- See the following page regarding each setting. **Setup Menu** “F-1 INPUT”, “L-1 OUTPUT”, “L-1 INPUT”, “L-2 SELECT” [P114] 35 – 38
- During progressive scan, viewing is not possible as the images are distorted.

■ Possible combinations

L-2 SELECT (*1)	L-1 OUTPUT			
	SCART VIDEO	SCART S-VIDEO	SCART RGB	COMPONENT (*2)
VIDEO/RGB	✓	✓	✓	✓
S-VIDEO/RGB	✓	✓	✓	✓
SAT VIDEO/RGB	✓		✓	✓ (*3)
DECODER (*5)	✓			✓ (*3)
L-1 INPUT				
VIDEO	✓	✓	✓	✓
S-VIDEO	✓ (*4)			✓ (*4)

*1 Switching to RGB signals is automatic.

*2 Component videos will be output from the [COMPONENT] terminal. Be sure to set to “COMPONENT” if viewing via component video.

*3 With this setting, signals from the [L-2 IN/DECODER] terminal will be output to the [L-1 IN/OUT] terminal even if this unit is turned off, except during EPG data downloading.

*4 This setting cannot be made if “L-2 SELECT” is set to “SAT VIDEO/RGB” or “DECODER”.

*5 Will not be displayed if “ČESKÁ REPUBLIKA”, “MAGYARORSZÁG”, “POLSKA” or “OTHER EASTERN” is selected for area setting.

1 Access the setup menu.



2 Select “FUNCTION SET UP”.

3 Select “VIDEO IN/OUT”.

SELECT

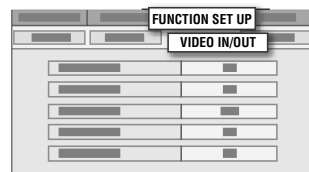
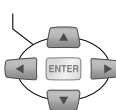

4 Set the input/output terminal.

1 Select and confirm on “F-1 INPUT”.

SELECT

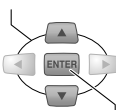

CONFIRM

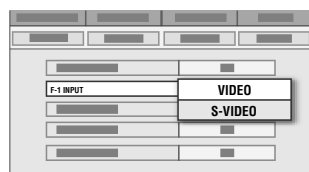

2 Select and confirm on “L-1 OUTPUT”.

3 Select and confirm on “L-1 INPUT”.

4 Select and confirm on “L-2 SELECT”.

- See the description below for the combinations of settings.

5 Exit setup.



The GUIDE Plus+ System Setup

- ▶ Before using the GUIDE Plus+ system, you need to perform initial setup to enable receiving of the host channel carrying the programme data. Take note of the setting especially if you are using an external receiver. For more information on setting up the GUIDE Plus+ system, please visit www.europe.guideplus.com.

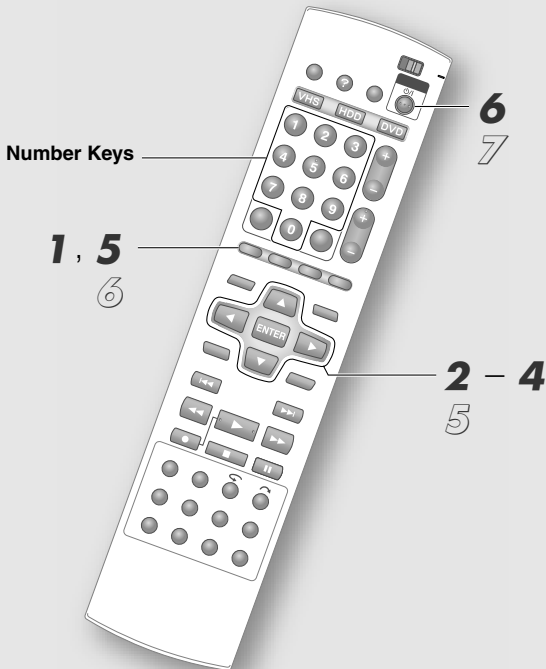

IMPORTANT:

- For information on the GUIDE Plus+ system, see the following page. “The GUIDE Plus+ System” [P32]
- If you are using an external receiver, set your external receiver channel to an appropriate host channel. See “Host Channel List” [P33].
- If you have moved to an area where the GUIDE Plus+ system is not available, press **ENTER** without entering the postal code at the “Postal Code” entry screen, or set “Country” to “Others”.

1 Access the GUIDE Plus+ system.



- “Grid” of the Menu Bar is selected.

2 Select “Setup”.

- “Setup” is hidden on the right of the Menu Bar. Press **Selection Key** (▶) repeatedly until it appears.

3 Select “Settings”.

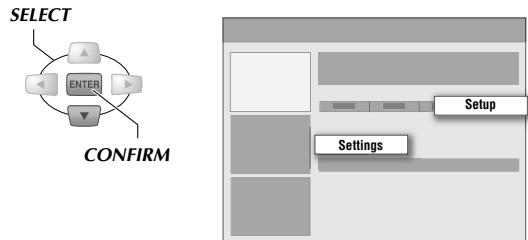

- Check that the “Language” and “Country” options are as set by auto setup.

4 Enter the postal code.

1 Select “Postal Code”.

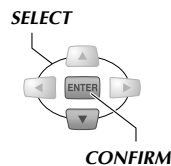

- The entry screen for postal code will be displayed.

2 Enter the number.

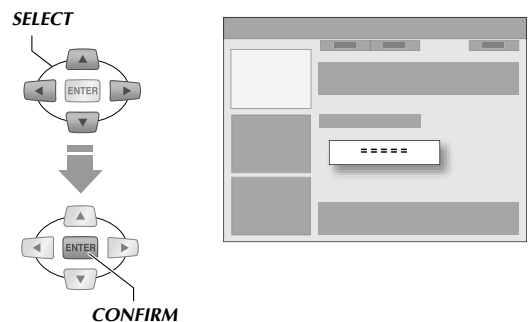

- Can also be entered using the **Number Keys**.

3 Confirm.

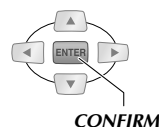

- Press **ENTER** when the confirmation screen is displayed.
- Returns to the “Setup” screen.

If not using an external receiver

5 Exit setup.



Proceed to step 6.

If using an external receiver

5 Set up the external receiver.

- 1 Select "External Receiver 1".

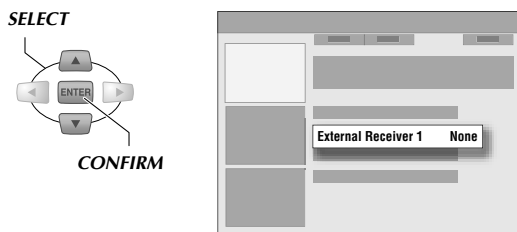

- 2 Check the message screen.

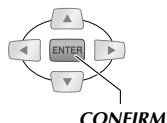

- 3 Select and confirm on the type of reception.

- Select "Cable", "Satellite" or "Terrestrial".

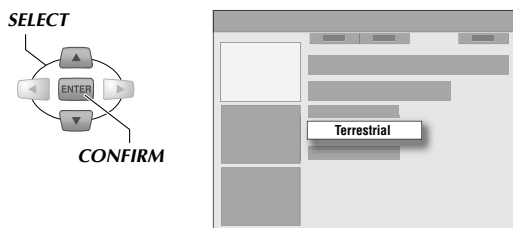

- 4 Select and confirm on the provider.

- 5 Select and confirm on the brand.

- 6 Select and confirm on the socket.

- Specify the terminal connected to the external receiver.

- 7 After the message is displayed, check and confirm on the connection.

- The control signals are transmitted to the external receiver in the test.

- 8 Confirm the completion message.

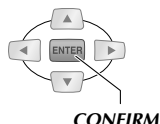

- Returns to the "Setup" screen.

Set up a second or third external receiver if necessary.

6 Exit setup.



Proceed to step 7.

Download programme data before using the GUIDE Plus+ system.

6 / 7 Turn off this unit.



- It takes about 24 hours to download sufficient data.
- If the unit is turned on while downloading, the download will be cancelled.
- The programme listing data download is given priority from 03:00 to 04:30, and VPS/PDC recording cannot be performed properly. Set "VPS/PDC" to "OFF" if performing timer recording at this time.
- "EPG" is displayed on the front display panel during downloading.
- If you are using an external receiver, leave it on and tune to your Host Channel. "Host Channel List" [P33]

If your external receiver is not in the list (Alternate Setup)

Operate from step 5.

- 1 Select and confirm on "None" for the brand setting.

- 2 Exit setup.



- 3 Tune the external receiver's channel to the host channel.

- Refer to "Host Channel List" [P33].

- 4 Leave the external receiver on.

- 5 Turn off this unit, and wait for one night.







The GUIDE Plus+ system will be automatically updated. As new receivers will be added, search for your receiver and complete the settings.

In order to use the programme listing, you need to download the programme data using the new settings. Turn off this unit, and wait for one more night.

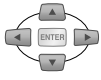
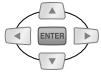
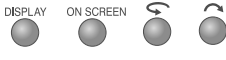
The GUIDE Plus+ System

Operation of Remote Control Buttons

GUIDE		To access the GUIDE Plus+ system.
Selection Keys		To navigate the GUIDE Plus+ system.
ENTER		To confirm an option or to exit the GUIDE Plus+ system and tune directly to a currently running programme.
Action		The Red, Green, Yellow and Blue buttons perform operations corresponding to the "Action Bar".
INFO		To expand the Information Box for viewing a long synopsis.
DAY(-/+)		To go directly to the previous or next day.
PAGE+/-		To browse the pages.
Number Keys		For direct entry of numbers.

Screen Layout of the GUIDE Plus+ System

Video Window

You can watch the current selected channel even while accessing the GUIDE Plus+ system.

Menu Bar

For selecting the function area.

Action Bar

Various operations and functions made to respond to the 4 coloured buttons on the remote control.

Highlight

Changes colour to indicate the selected state.

Information Box

Displays simple programme explanation and help.

Information Panels

Displays programme promotions or operating instructions.

Grid

Displays the programme based on the station and time. Can display up to 7 days of programme.

NOTE:

- If white triangle marks are displayed on the screen, it indicates that there are hidden items. Press the **Selection Keys** (△▽◀▶) that correspond to the respective marks.

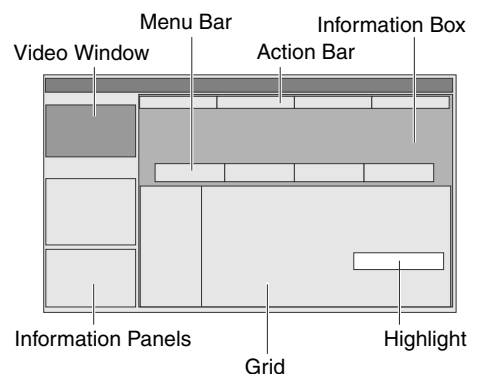

Types of Area

Select the area on the Menu Bar.

Grid

- The screen initially displayed when **GUIDE** is pressed. (This is the “Home” area.)
- Offers information about the programmes.
- You can select a programme to timer record and remind (watch).

Search

- You can perform a search narrowed down to category, or search by keyword to look for programmes.
- You can select a programme to timer record and remind (watch).

My TV

- You can register your favourite channels or programme categories.

Schedule

- Displays programmes that have been timer programmed.
- You can edit or cancel the timer programme.
- You can set timer programming and reminder for watching using **SHOWVIEW**.

Info

- News, weather information, and stock price information, etc. are scheduled to be displayed in the future.

Editor

- The channel display/hide, reception method, and programme number of the channel settings set by auto setup can be changed.

Setup

- For performing basic settings such as language, country, postal code and external receiver.

■ Host Channel List

Country/Region (Language)	Host Channels	Helpful Hints
Austria	Eurosport	
Belgium (Flanders)	Music Factory (TMF)	
France	Canal +	Analogue only
Germany	Eurosport	
Italy	Sport Italia	Analogue only
Netherlands	Music Factory (TMF), Eurosport	Use TMF if you live in Amsterdam, Eindhoven or Rotterdam.
Spain	Tele 5	Analogue only
Switzerland (German)	Eurosport	
United Kingdom	ITV, Eurosport	ITV is analogue only. Use Eurosport if you are a BSkyB subscriber and you no longer have a terrestrial antenna available.

Editor Area

1 Access the **GUIDE Plus+** system.



2 Select “Editor”.

SELECT

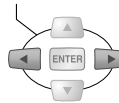

3 Set display/hide.

1 Select the left tile of your desired broadcast station.

SELECT

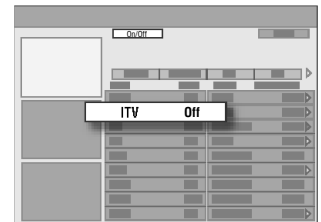
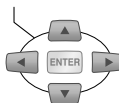

2 Press the Action (RED) button.

- Switches between display/hide with each press.

4 Set the reception method and programme number.

1 Select the right tile of your desired broadcast station.

SELECT

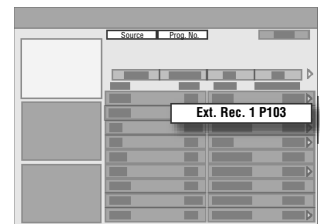
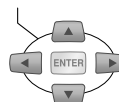

2 Press the Action (RED) button.

- Switches between “Tuner” and external receivers.

3 Press the Action (GREEN) button to change the programme number.

- Enter the programme number for the channel using the **Number Keys**.
- Make sure you enter a correct number.

When settings are completed, confirm the changes on “Grid” of Menu Bar.

Clock Setting

- Usually performed automatically using auto setup or preset download. If cannot be set automatically in some regions, set them manually.

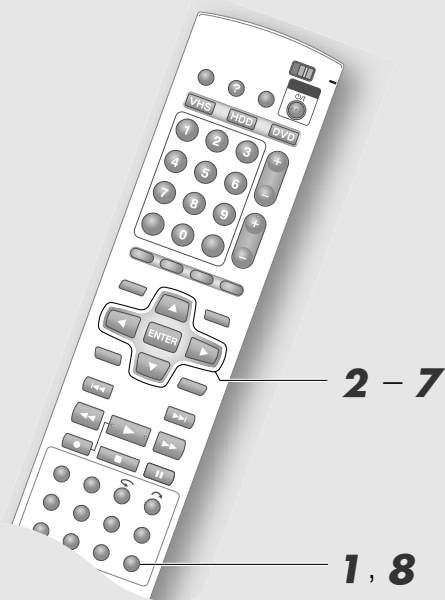

NOTES:

- Just Clock (when set to “ON”) adjusts the unit’s built-in clock every 3 hours from 03:00 to 21:00. The unit’s clock is also automatically adjusted at the start/end of Summer Time.
- Just Clock functions by the PDC signal.
- Just Clock does not function in the following instances.
 - When the unit is on.
 - When the clock is not set.
 - When “ČESKÁ REPUBLIKA”, “MAGYARORSZÁG”, “POLSKA” or “OTHER EASTERN” is selected for the area setting.
 - During timer recording, EPG data downloading or Automatic Satellite Programme Recording.
 - When “L-2 SELECT” is set to “SAT VIDEO/RGB” or “SAT S-VIDEO/RGB”.
 - When the reception is poor.

IMPORTANT:

- The default setting for Just Clock is “OFF”.
- It is recommended to set to “ON” in areas where the PDC signal can be properly received. Set to “OFF” in areas where the signal is unstable.

1 Access the setup menu.



2 Select “INITIAL SET UP”.

SELECT

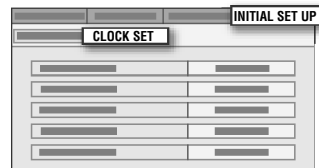
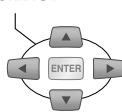

3 Select “CLOCK SET”.

SELECT

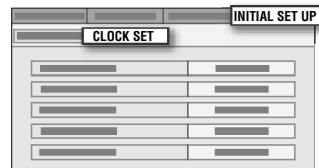
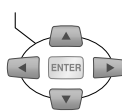

4 Select and confirm on “YEAR”.

SELECT

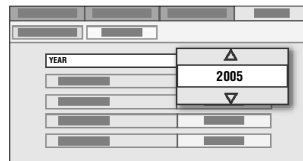
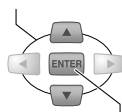

CONFIRM

5 Select and confirm on “DATE”.

SELECT

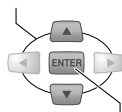

CONFIRM

- Press and hold the **Selection Keys** (Δ∇) to change the “DATE” in 15-day intervals.

6 Select and confirm on “TIME”.

SELECT

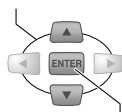

CONFIRM

- Press and hold the **Selection Keys** (Δ∇) to change the “TIME” in 30-minute intervals.

7 Set “JUST CLOCK”.

1 Select and confirm on “JUST CLOCK”.

2 Select “TV PROGRAMME” to set the channel.

8 Exit setup.



SHOWVIEW Guide Channel Set

- Usually performed automatically using auto setup. Set if channel settings are performed manually, or if the receiving channel differs from the channel set using SHOWVIEW timer programming.

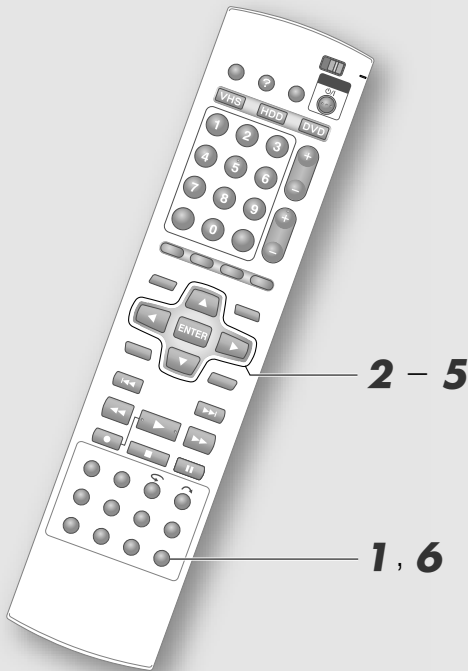

NOTES:

- Guide programme numbers are assigned to the TV stations of the respective broadcast areas, for SHOWVIEW timer programming. These numbers can be found in most TV programme listings.
- Guide channel set will not be performed automatically when channel settings have been made using preset download.

1 Access the setup menu.



2 Select "INITIAL SET UP".

3 Select "TUNER SET".

4 Select "GUIDE PROG SET".



- The "GUIDE PROG SET" screen will be displayed.

5 Set the guide channel.

1 Select and confirm on "GUIDE PROG".



- Select the TV station's guide programme number from the programme listing.

2 Select and confirm on "TV PROG".

- Select the channel number of the TV station set on this unit.

6 Exit setup.



Setting Receiving Channels

- Usually performed automatically using auto setup or preset download. If cannot be set automatically in some regions, set them manually.

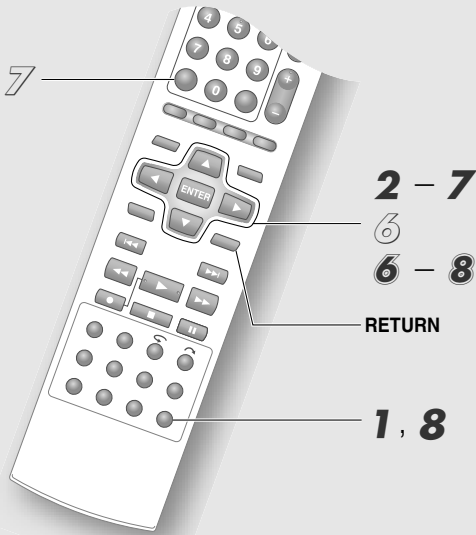

IMPORTANT:

- If channel settings are performed manually, the SHOWVIEW guide channel will not be set. See “SHOWVIEW Guide Channel Set” [P35].

1 Access the setup menu.



2 Select “INITIAL SET UP”.

3 Select “TUNER SET”.

4 Select “MANUAL CH SET”.

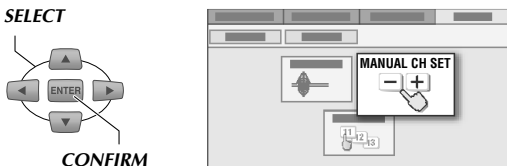

- The “MANUAL CH SET” screen will be displayed.

5 Select “EDIT”.



6 Select a channel that you want to set.

- A confirmation screen will be displayed.

7 Set the channel.

1 Select and confirm on “BAND”.

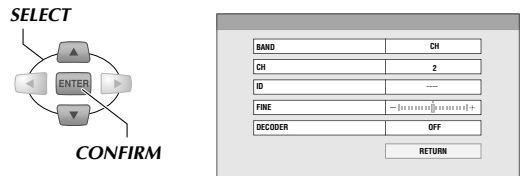

- “CH” is a regular broadcast band, and “CC” is a cable broadcast band.

2 Select and confirm on “CH”.

- Select a receiving channel.

3 Select and confirm on “ID”.

- Select from the “TV Station and ID List” [P116].
- See “Entering the Station ID” [P37].

4 Select and confirm on “FINE”.

- If the reception is poor, press the Selection Keys (Δ∇) to fine-tune.

5 Select and confirm on “DECODER”.

- When a decoder is connected, set to “ON”.
- Unable to change the setting other than the following.

Setup Menu “L-2 SELECT” = “DECODER” [P114] 38

8 Exit setup.



- If RETURN is pressed, you will return to the previous screen, and other channels can also be set.

Deleting a channel

Operate up to step 5.

6 Select a channel that you want to delete.



7 Delete.

- If the channel is deleted, subsequent channels will move forward one by one.



Shifting the channel position

Operate up to step 5.

6 Select "MOVE".

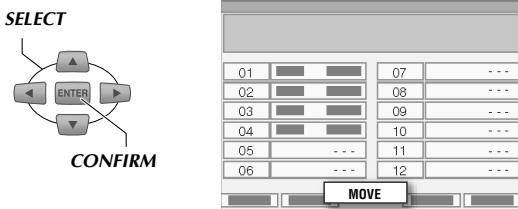

7 Select a channel that you want to move.

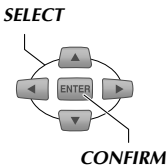

8 Select the destination channel.

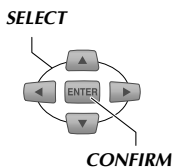

- If the channel is moved, other channels will move one by one.

Entering the Station ID

- 1 Select and confirm on "ID" on the confirmation screen.
 - The entry screen for Station ID will be displayed.
- 2 Select the registered ID, or enter your desired ID name.



- A maximum of 4 characters can be entered.

- 3 Select and confirm on "OK".

"DECODER" setting

- If you live in Eastern Europe, "TV SYSTEM" will be displayed instead of "DECODER" on the confirmation screen.
- If the broadcast image can be seen but cannot be heard properly, set the "TV SYSTEM".
- Usually, the broadcast system for Eastern Europe and Western Europe is D/K and B/G respectively.

Basic Recording (HDD/DVD)



- ▶ TV programmes can be recorded to the HDD or a DVD disc with ease.
- ▶ You can record up to 500 programmes on the HDD, and 99 programmes on one DVD disc. Simultaneous recording on HDD/DVD and VHS cannot be done.

PREPARATION:

- Switch TV/DVD on the remote control to DVD.

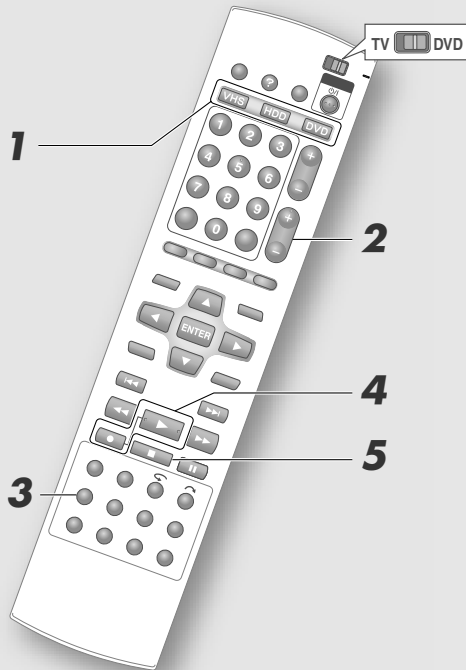

IMPORTANT:

- When using a brand-new DVD-RW/R disc, formatting may be required. [P66]
- The maximum continuous recording time at the HDD is 48 hours.
- See the following page if recording a bilingual programme using DVD-RW/R (Video mode). "Sound" [P100]

1 Select the recording deck.

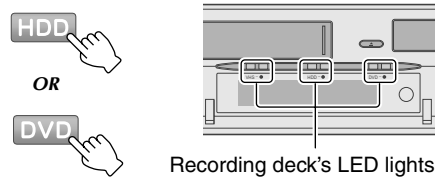

Recording deck's LED lights up

- When HDD is selected, proceed to step 2.

When DVD is selected

1 Press OPEN/CLOSE on the unit.

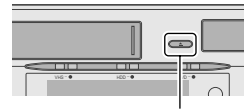

OPEN/CLOSE

2 Load a recordable disc.

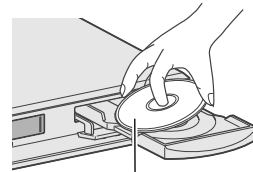

Face the label side upwards

3 Press OPEN/CLOSE to close the disc tray.

- It takes some time to read the disc.

2 Select a channel.

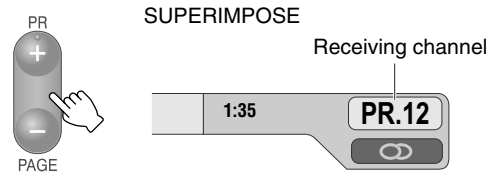

- Press ON SCREEN if the information screen is not displayed.

3 Select the recording mode.

1 Display the recording mode.

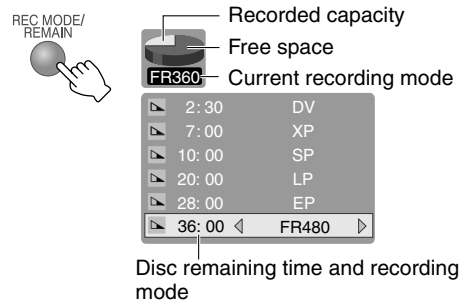

Disc remaining time and recording mode

2 Select the recording mode.



- Usually select SP (standard) mode.
- The recording mode changes each time **REC MODE/REMAIN** is pressed.
- Pressing the **Selection Keys** (Δ / ∇) also changes it.
- See “Recording Mode” [P92].
- Recordable time for each recording mode. The shorter the recordable time, the higher the image quality.

Recording mode	DVD	HDD
DV	—	11 hours
XP	1 hour	34 hours
SP	2 hours	69 hours
LP	4 hours	138 hours
EP	6 hours	209 hours
FR480	8 hours	300 hours

(The numbers shown are estimates.)

3 Confirm.

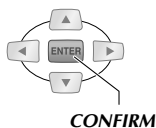

CONFIRM

4 Start recording.

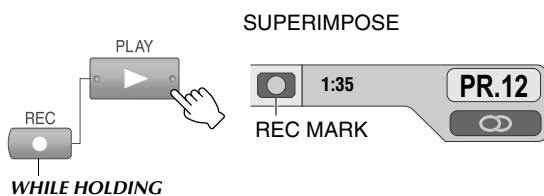

- When operating from the unit, press **REC**.

5 End recording.



PRESS TWICE

- In the case of DVD disc, “PLEASE WAIT” is displayed. Do not turn off the unit while it is being displayed.

Possible operations during recording

To pause



- The pause function for HDD is possible only during external input (L-1/L-2/F-1/dv) recording.

To resume recording



To specify recording stop time (Instant Timer Recording)

Unit's record button

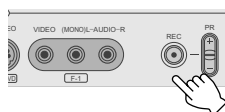

Display on bottom right screen



- The recording time from the current time can be set.
- The disc mark on the front display panel blinks.
- The recording end time switches each time **REC** (●) on the unit is pressed.
 - A maximum of up to 6 hours can be set in 30-minute intervals.
 - To cancel, press the button a few times until the set time is cleared.

DIRECT REC

If the following setting is enabled, the channel showing on the TV can be recorded instantly.

Setup Menu “DIRECT REC” = “ON”
[P112] 24

While watching on TV

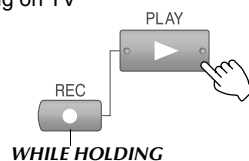

- This function is possible if connected using a T-V Link compatible TV and SCART cable.
- “—” is displayed on the front display panel during recording.

Basic Recording (VHS)



- ▶ TV programmes can be recorded to a VHS tape with ease.
- ▶ Simultaneous recording on HDD/DVD and VHS cannot be done.

NOTE:

- Switch **TV/DVD** on the remote control to **DVD**.

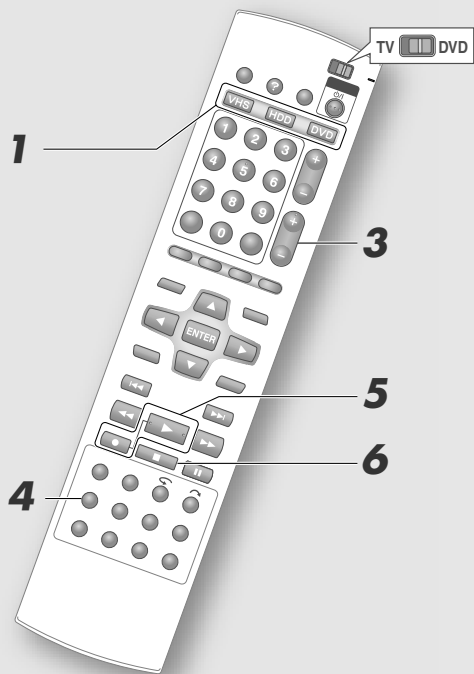

IMPORTANT:

- Set the following when you wish to record both the main/sub audio of bilingual programmes on VHS tapes. **Setup Menu** “AUDIO REC” = “NICAM” [**P112**] **23**
- Signals that are input from the external receiver may not be recordable on VHS.

1 Select the recording deck.

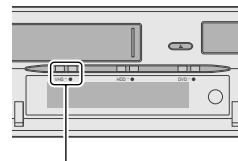

VHS lamp lights up

2 Load a recordable tape.

- Load a tape with the record safety tab intact.
- With the window side facing up, push the tape in slowly at the midportion.

3 Select a channel.

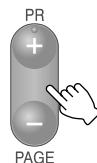

- The channel being selected is displayed on the top left screen.
- If the information screen is not displayed, press **ON SCREEN** to display.

4 Select the recording mode.

1 Display the recording mode.

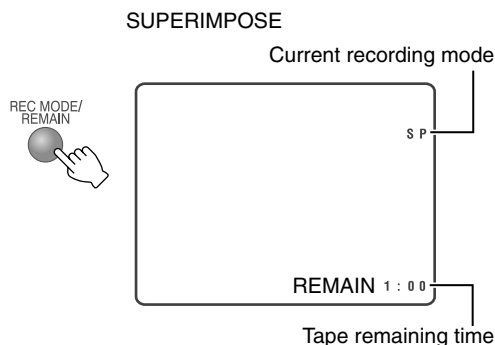

2 Select the recording mode.



- The recording mode changes each time **REC MODE/REMAIN** is pressed.
- See “Recording Mode” [**P92**].
- Recordable time for each recording mode. The shorter the recordable time, the higher the image quality.

Recording mode	VHS (when using E-240)
SP	4 hours
LP	8 hours

5 Start recording.

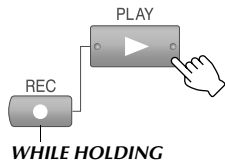

- When operating from the unit, press **REC**.

6 End recording.

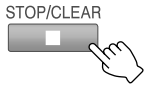

Possible operations during recording

■ To pause

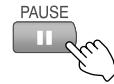

■ To resume recording

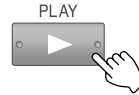

■ To specify recording stop time (Instant Timer Recording)

Unit's record button



- The recording time from the current time can be set.
- The record mark on the front display panel blinks.
- The recording end time switches each time **REC** (●) on the unit is pressed.
 - A maximum of up to 6 hours can be set in 30-minute intervals.
 - To cancel, press the button a few times until the set time is cleared.

Basic Playback (Library Database Navigation)



- ▶ Play back recorded programmes using Library Database Navigation. Library Database Navigation cannot be used for finalised DVD-RW-R (Video mode) discs. Press **TOP MENU** or **MENU** to play back.

PREPARATION:

- Switch **TV/DVD** on the remote control to **DVD**.

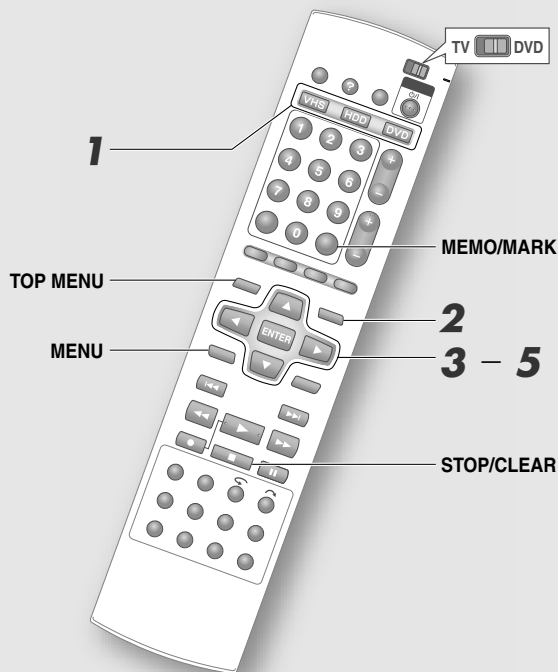

NOTE:

- When recording in DV mode, playback on the HDD or DVD is not possible.

1 Select the playback deck.

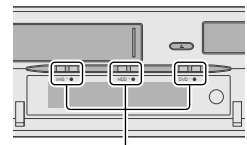

Playback deck's LED lights up

- When HDD is selected, proceed to step **2**.

When DVD is selected

1 Press OPEN/CLOSE on the unit.

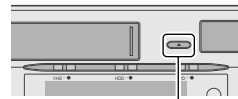

OPEN/CLOSE

2 Load the disc to be played.

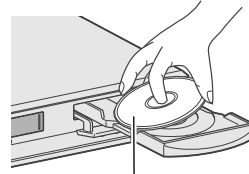

Face the label side upwards

3 Press OPEN/CLOSE to close the disc tray.



- It takes some time to read the disc.

2 Display the Library Database Navigation screen.

(On-screen display for DVD)

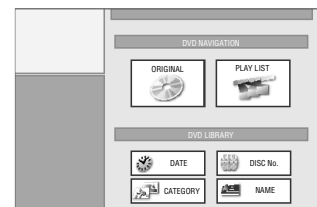

3 Select "ORIGINAL".

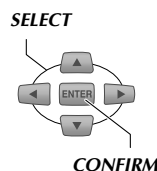

4 Select the programme that you wish to watch from the thumbnails.

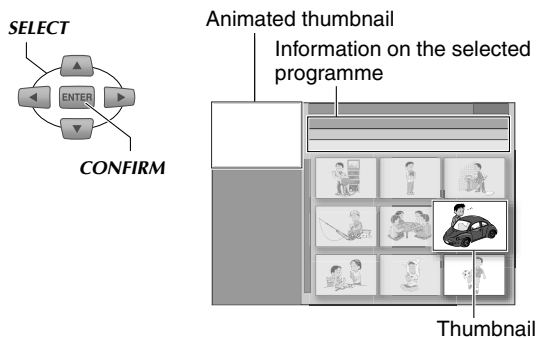

- Thumbnails are arranged in order of recording date and time.
- A “NEW” mark is displayed on the thumbnails of programmes that have not been watched.
- Pages can be advanced using **TOP MENU** or **MENU**. To return to the beginning page or advance to the last page, press and hold the button.

5 Select “BEGINNING”.



- Playback begins.
- If “RESUME” is selected, playback begins from the point where it previously stopped.
- To repeat playback, select “REPEAT”.
- If playing a DVD disc, the playback method changes with the following setting. **Setup Menu** “CONTINUOUS PLAY” [**P111**] **12**
 - “ON”: Plays back till the last recorded programme.
 - “OFF”: Plays back only the selected programme.
- To return to the thumbnail screen, press **RETURN**.

To watch programmes in the desired order (Programme Playback)

- ① Press **MEMO/MARK** in step 4.
 - The number of the playback order will be displayed on the thumbnail.
 - To cancel the memory, press **MEMO/MARK** again.
 - Up to 8 programmes can be selected.
 - To clear the order, press **CANCEL**.
- ② Press **ENTER** to play back.
 - To quit in the process of setting, press **STOP/CLEAR**. (The order will also be cleared.)

NOTE:

- Programme playback is not possible if there is a combination of programmes in DV mode and other recording modes.

Usable Buttons during Playback (HDD/DVD)



IMPORTANT:

Marks

For HDD, DVD-RAM and DVD-RW/-R (VR mode)

- Marks can be set or deleted during playback.
- They are automatically inserted if the audio is switched from monaural or bilingual broadcast to stereo broadcast during recording.
- “CHAPTER” on the Editing screen can also be used to insert marks. [P83]

For DVD-RW/-R (Video mode)

- Marks are automatically inserted approximately every 5 minutes during recording.

The marks will remain even after finalising.

See “Watching on Other DVD Players (Finalising)” [P67].

The following buttons can be used during playback.

	Playback	<ul style="list-style-type: none"> • Starts playback.
	Stop	<ul style="list-style-type: none"> • Stops playback and displays the broadcast screen. • Memorises the point where playback stops. (Setup Menu “RESUME” [P110] [08])
	Pause	<ul style="list-style-type: none"> • Pauses playback and displays a still image.
 	Reverse Search/Forward Search	<ul style="list-style-type: none"> • Functions during playback. <p>HDD</p> <ul style="list-style-type: none"> • Each press of the button switches the playback speed in the order of FWD1 - FWD5. • When not recording, pressing once activates playback at 1.5x speed with sound. • Press once to reverse playback. <p>DVD</p> <ul style="list-style-type: none"> • Each press of the button switches the playback speed in the order of FWD1 - FWD4. • Press once to reverse playback.
	Frame-By-Frame/Slow Motion Playback	<ul style="list-style-type: none"> • Functions during pause. • Each press of the button advances or reverses one frame at a time (frame-by-frame playback). • Pressing down for 2 or more seconds activates slow motion playback. Each press of the button changes the playback speed to one of 3 stages in the order of 1/16, 1/4 and 1/2 times the original.
	Skip	<ul style="list-style-type: none"> • Moves to the chapter position (mark). • Marks can be added during playback using MEMO/MARK. See “Mark” below.
	Jump	<ul style="list-style-type: none"> • Jumps according to the selected time interval and resumes playback. (Setup Menu “JUMP TIME” [P112] [26]) • Functions when the chapter (mark) is not set.
	Skip Search	<ul style="list-style-type: none"> • Skips forward for approximately 30 seconds and resumes playback. • Pressing repeatedly skips forward continuously as many times as pressed.
	One Touch Replay	<ul style="list-style-type: none"> • Skips back for approximately 7 seconds and resumes playback. • Pressing repeatedly skips back continuously as many times as pressed.
	Mark	<ul style="list-style-type: none"> • Inserts mark at the desired skip position. • To insert marks: Press at desired positions during playback. (Screen display: MARK) • To delete marks: While in pause mode, press after using skip buttons to locate the marks to be deleted. (Screen Display: MARK)

It is possible to switch between the elapsed time/disc remaining time/programme remaining time display of each programme by pressing **DISPLAY**.

Timer Programming Guide



What kind of programming methods are there?



6 Ways to Programme

The GUIDE Plus+ system

From the “Grid” area [📖 P46]

Search programmes by channel and time using the screen’s programme listing to set recording (programming).

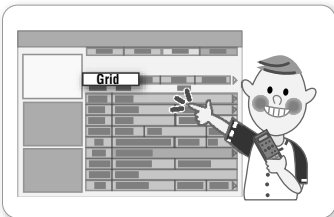

From the “Schedule” area

“SHOWVIEW” [📖 P47]
Set recording (programming) by simply entering the SHOWVIEW number.



From the “Search” area [📖 P50]

Search desired programmes by category of interest or keyword to set recording (programming).

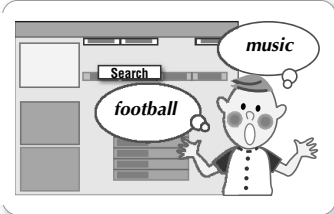

Programme navigation

Calendar timer programming [📖 P54]

Specify date and time from the screen calendar to set recording (programming).

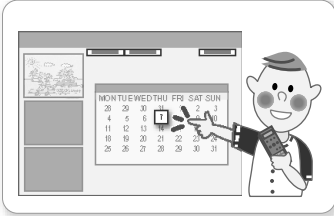

“SHOWVIEW” [📖 P52]

Set recording (programming) by simply entering the SHOWVIEW number.

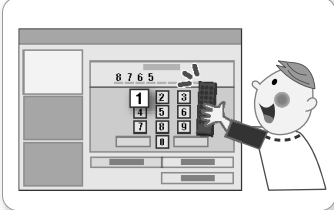

Timer Programming Using Programme Listing (The GUIDE Plus+ System)



- ▶ Timer programming can be done easily from the programme listing by simply pressing the buttons. (One-Button-Record)
- ▶ You can programme a maximum of 16 programmes up to 7 days in advance, including other programmes, within 1 month.

PREPARATION:

- Switch TV/DVD on the remote control to DVD.

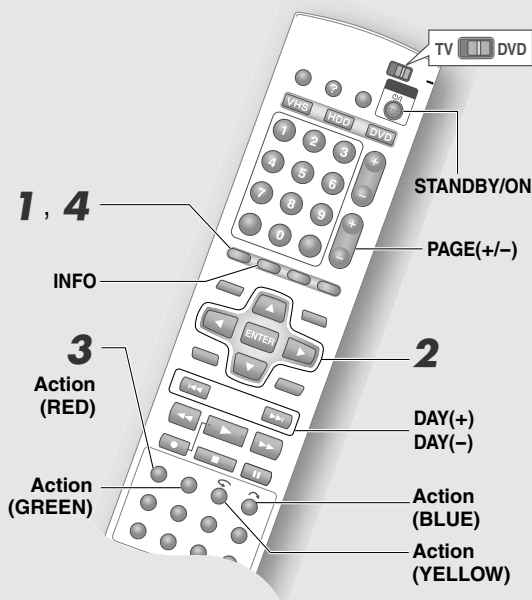

IMPORTANT:

- Timer programming on the VHS is not possible.

NOTES:

- Countries that can receive the programme listing are Austria, Belgium, France, Germany, the Netherlands, Spain, Switzerland, Italy, the United Kingdom, and Luxembourg.
- Recording settings for One-Button-Record will be as follows.
 - Recording mode: Recording mode currently set (HDD)
 - Recording interval: "Once"
 - Recording deck: The last recording deck (other than VHS) that has been set.

In addition, the recording date and time, programme name, etc. will be recorded.

- If you wish to change the recording settings, edit from the "Schedule" area screen. See "If setting the recording deck, recording mode, etc." [P49].
- Returns to the "Grid" area screen when the **Action (BLUE)** button is pressed.

1 Access the GUIDE Plus+ system.



- The "Grid" area screen will be displayed.

2 Select a programme.

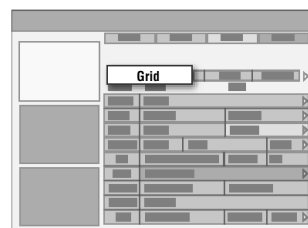
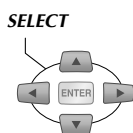

- Go to channels on another page using **PAGE+/-**, and change to another date using **DAY(+)** and **DAY(-)**.

3 Set timer recording.



- The programme set for timer recording changes to red.
- If a programme currently being broadcasted is selected, recording will start approximately 5 seconds after the timer recording is set.

To continue with other timer programmings, repeat step **2-3**.

4 Exit programming setup.



- Press **STANDBY/ON** to turn off when not performing other operations.

To programme for watching

Programming can be done to avoid missing programmes. Recording will not be performed.

A maximum of 8 programmes up to 7 days in advance can be programmed.

① Select a programme.

② Press the **Action (GREEN)** button.

- The programme set for watching changes to orange.

NOTES:

- If this unit is off, it will not turn on even if the start time of the programme set for watching is reached.

- If performing operations like playback or recording when the start time of the programme set for watching is reached, this unit will switch to the channel programmed for watching only upon completing these operations.

Timer Programming Using ShowView Number in the Programme Listing

Timer programming can be set simply by entering the number.

- ① Access the **GUIDE Plus+** system.



- ② Select "Schedule".
- ③ Select "ShowView".

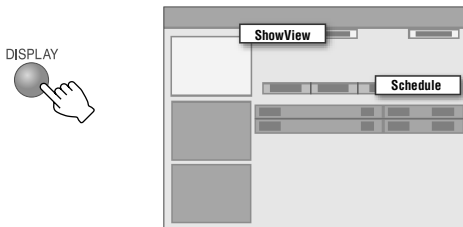

- ④ Enter the **SHOWVIEW** number.

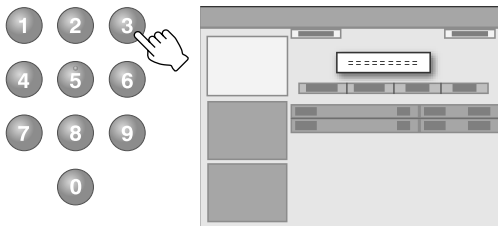

- To re-enter the number, press the **Action (GREEN)** button.

- ⑤ Confirm.

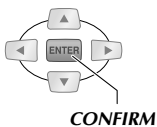

NOTE:

- If you wish to change the recording settings, edit from the "Schedule" area screen. See "If setting the recording deck, recording mode, etc." [P49].

Useful Functions of the Programme Listing

To unlock the Video Window

When searching for programmes using the Grid screen, the Video Window will change its display accordingly if you move to another channel.

- ① Move to the channel logo at the left end of Grid.
- ② Press the **Action (RED)** button.
 - The lock icon on the upper right of Video Window changes to an open lock icon.

NOTE:

- To lock, press the **Action (RED)** button again.

Channel (mosaic) screen display

Logos of channels that can be watched will be displayed as mosaic. When displaying channel information, the target channel can easily be found.

- Channels are available when the Action (YELLOW) display button on the screen is displayed as "Channels".

- ① Press the **Action (YELLOW)** button.



Additional information on programmes

When an  icon is displayed at the bottom-right of the Information Box, additional information on that programme is available.

- ① Press **INFO**.

Manual Timer Programming (The GUIDE Plus+ System)



- ▶ Timer programming can be done by specifying the date, time and channel as manual programming settings on the GUIDE Plus+ system screen.
- ▶ You can programme a maximum of 16 programmes up to 7 days in advance, including other programmes, within 1 month.

PREPARATION:

- Load a recordable disc when recording to a DVD disc. [P12]

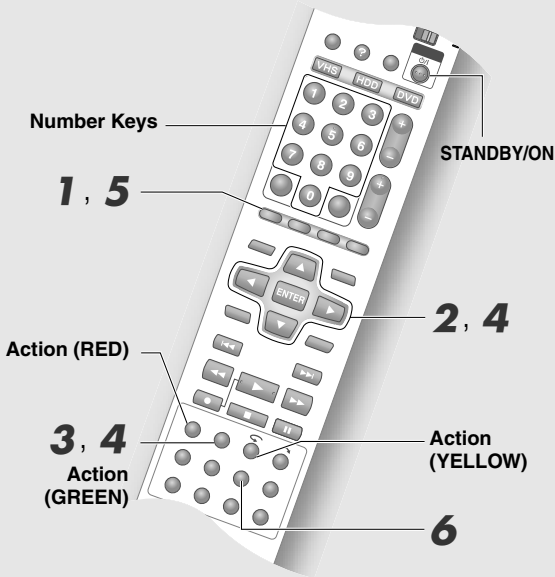

IMPORTANT:

- Timer programming on the VHS is not possible.

CAUTION:

- In step 4, you can press the **Action (RED)** button to return to a previous screen. However, the timer programme settings will be erased if you return to the initial "Schedule" screen. Confirm one at a time then press the button.

1 Access the GUIDE Plus+ system.



- The "Grid" area screen will be displayed.

2 Select "Schedule".

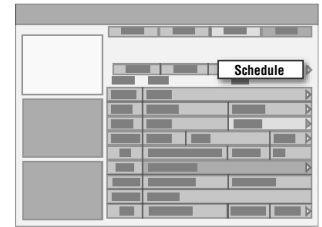
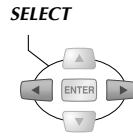

3 Select "Manual".

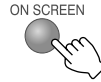

4 Set timer recording.

1 Set the recording date.

SELECT

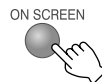
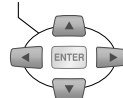

- Press the **Selection Keys** (<>) to select, and (<>) to change.
- Can also be entered using the **Number Keys**.
- Press the **Action (GREEN)** button for confirmation.

2 Set the recording start time.

3 Set the recording end time.

4 Set the recording channel.

- Can also be set from the channel (mosaic) screen.

5 Set a name for the timer programme settings.

- The Virtual Keyboard screen will be displayed.

SELECT

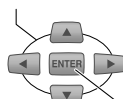

CONFIRM

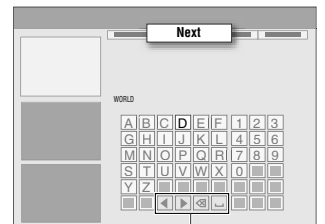

Cursor movement, backspace & space entry

- To change the character set, press the **Action (YELLOW)** button.

6 Select and confirm on “Save”.

SELECT

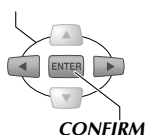

- The “Schedule” area screen is displayed, with the new timer programme added.
- If you do not wish to save, select “Don’t save”, then press **ENTER**.



If setting the recording deck, recording mode, etc.

To set the recording deck, recording mode, recording interval, etc. operate as a change of timer programme.

7 Confirm that the tile on the right of the added timer programme is selected.

SELECT

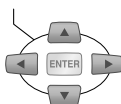

8 Set the recording deck.

DISPLAY



- Switches between “HDD” and “DVD” each time the button is pressed.

9 Set the recording mode.

ON SCREEN



- The recording mode switches each time the button is pressed. See “Recording Mode” [P92].
- Setting the FR mode.
 1. Press **ENTER** when “FR**” appears.
 2. Enter the desired number using the **Number Keys**.
If the number entered does not exist in the recording mode, the nearest number in the recording mode will be selected.

(Example) If FR460 is entered, FR480 will be selected, as FR460 does not exist.

3. Press **ENTER** to confirm.

FR60 - FR360 can be set by 5-minute intervals, then follow by FR420 and FR480.

10 Set the recording interval.



- The weekly/daily recording setting switches each time the button is pressed. See “Weekly/Daily Timer Programming” [P94].

11 Set the timing for the end of recording.

SELECT

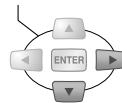

ON SCREEN



- Press **Selection Key** (▷) to display the hidden tile.
- You can extend the recording end time or set VPS/PDC by pressing the **Action (GREEN)** button.
- “Timing” extends the recording end time only for the time duration specified.

12 Set the category.



- The category switches each time the button is pressed.
- Cannot be set if the programme listing data is not downloaded.

To continue with other timer programmings, repeat step 4 - [1]-[12].

5 Exit programming setup.



- Press **STANDBY/ON** to turn off when not performing other operations.

To timer record using VPS/PDC

6 Press VPS/PDC.

- This unit turns off automatically and enters into recording standby mode.
- Ⓞ lights up on the front display panel indicating that VPS/PDC recording is activated.

Searching Programmes for Timer Programming (The GUIDE Plus+ System)



- ▶ Programmes can be searched by category. In addition, programmes related to the keywords entered can be searched.

PREPARATION:

- Load a recordable disc when recording to a DVD disc. [P12]

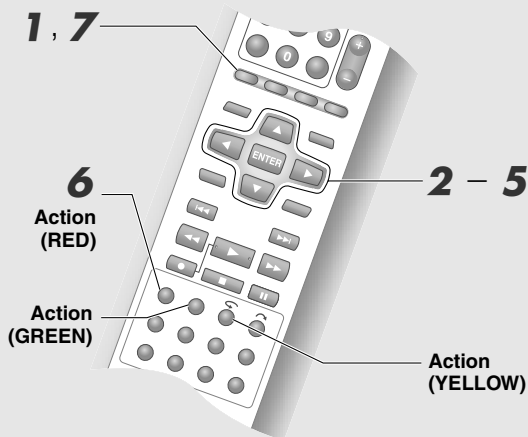

IMPORTANT:

- Timer programming on the VHS is not possible.

NOTE:

- Some categories are colour-coded.
 - “Movies”: Purple
 - “Sports”: Green
 - “Children”: Blue
 - “Others”/“My Choice”: Teal

3 Move to the category field.

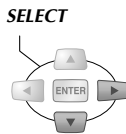

4 Select the category and sub-category.

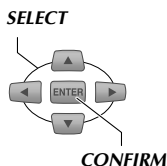

- The sub-categories vary depending on the GUIDE Plus+ system country/region.
- “My Choice” is a search by keyword. See “To Search by Keyword” [P51].

Programmes that match the specified category will be displayed.

5 Select a programme.

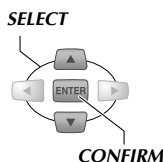

- Programmes found by searching will be displayed in order of date and time. To display the programme listing for the previous/next day, press the **Selection Keys** (◀▶) or **DAY**(-/+).

6 Set timer recording.



- Takes the programmed settings of One-Button-Record. Perform setting of other items from the “Schedule” area screen. See “If setting the recording deck, recording mode, etc.” [P49].

7 Exit programming setup.



- Press **STANDBY/ON** to turn off when not performing other operations.

1 Access the GUIDE Plus+ system.



- The “Grid” area screen will be displayed.

2 Select “Search”.

SELECT

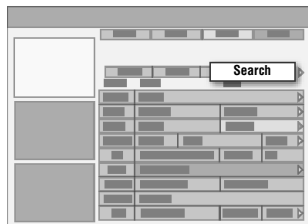
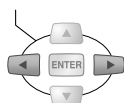

To Search by Keyword

You can search for a desired programme by specifying the words that appear in the title.

- 1 Select "My Choice" from the "Search" area screen.

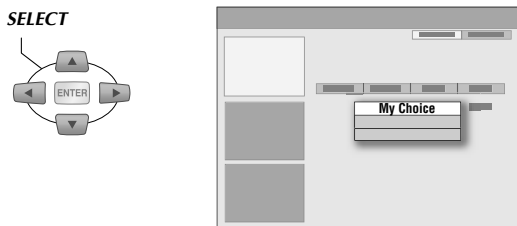

- If keywords have been registered previously, a keyword list will be displayed as menu.

- 2 Display the Virtual Keyboard.



- 3 Enter the characters.

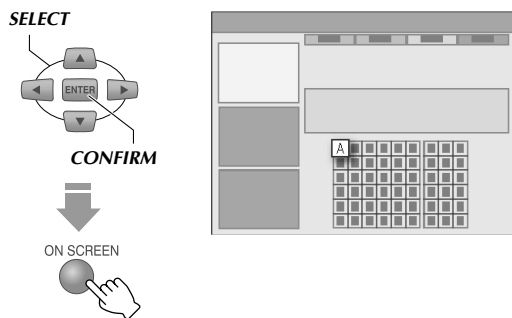

- The keyboard's character set changes when the **Action (YELLOW)** button is pressed.
- Press the **Action (GREEN)** button.

- 4 Select "Save" to register the keyword.

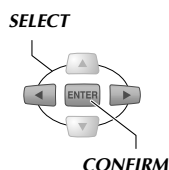

- The keyword entered will be displayed as menu in the keyword list.
- To cancel the character entry, press the **Action (RED)** button.
- If you do not wish to save, select "Don't save", then press **ENTER**.

- 5 Start the search.

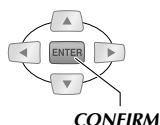

- At this time, check that the registered keyword is selected.

Using the "My TV" Area

Your favourite channels, categories and keywords can be compiled and memorised as a profile. Your desired programmes can be searched anytime by using this profile.

- 1 Select "My TV" from Menu Bar.
- 2 Add "Profile".

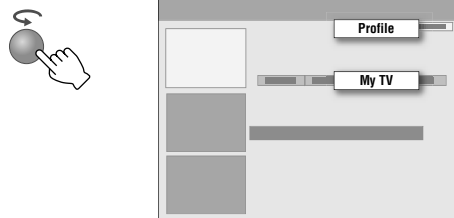

- 3 Select and add "Channels".

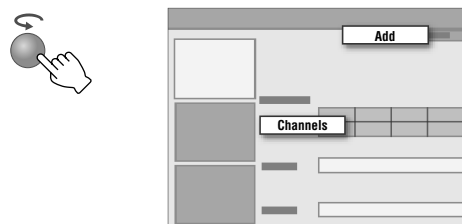

- Select from the channel (mosaic) screen, then press **ENTER**.
- A maximum of 16 channels can be set.

- 4 Select and add "Categories".

- Select the category as with the "Search" area.
- A maximum of 4 category types can be set.

- 5 Select and add "Keywords".

- Enter the keyword as with the keyword search.
- A maximum of 16 keywords can be set.

- 6 Search for programmes using the profile set.

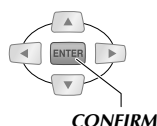

SHOWVIEW Timer Programming



- ▶ With SHOWVIEW system, timer programming can be set simply by entering the number corresponding to the TV programme.
- ▶ You can programme up to 16 programmes, including other programmes, within 1 month.

PREPARATION:

- Switch **TV/DVD** on the remote control to **DVD**.
- Load a recordable disc when recording to a DVD disc. [📖 P12]

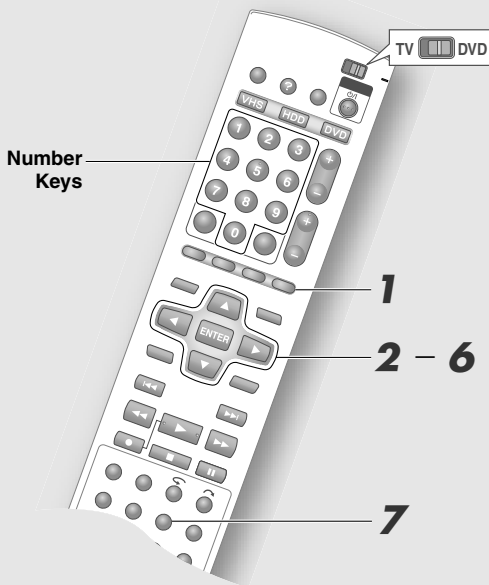

IMPORTANT:

- Timer programming of an external receiver cannot be set using the programme navigation.
- When you have moved to other regions, perform guide channel settings again. "SHOWVIEW Guide Channel Set" [📖 P35]
- Timer programming on the VHS is not possible.

NOTES:

- If there is inactivity for approximately 1 minute during setting, the settings will be cancelled and the screen will return to the broadcast screen.
- To discontinue programming, press **PROG** and select "EXIT".
- See "Timer Recording" [📖 P97].

1 Display the programme navigation screen.



2 Select "SHOWVIEW".

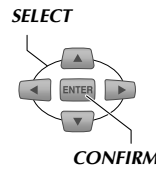

3 Set SHOWVIEW.

1 Enter the SHOWVIEW number.

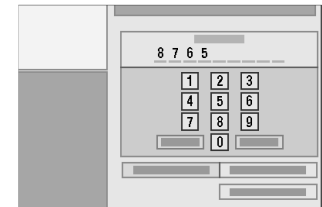
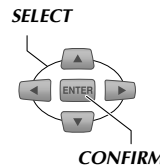

- Can also be entered using the **Number Keys**.
- 2 If necessary, select "RECORD TO", then select the recording deck.
 - 3 Select "CONFIRM".
 - When the number is invalid, an error message will be displayed.

If the guide channel has not been set

- 1 A warning screen will be displayed. Pressing **ENTER** displays the weekly/daily timer programme's recordable time limit.
- 2 Select "TV PROG", then the receiving channel.
 - Other items can also be set.
- 3 Select "CONFIRM".

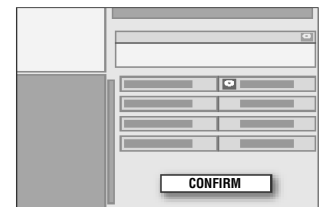
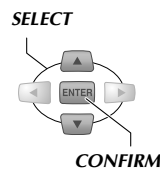

- The guide channel information of the channels available in "TV PROG" is stored on this unit.
- See "SHOWVIEW Guide Channel Set" [📖 P35].

4 If necessary, set recording options for timer programming.

- 1 Select **"INPUT TITLE"** to enter the title name.
 - See "Creating Programme Title" [📖 P82].
 - The title can be set later.
- 2 Select **"CATEGORY"** to set the category.
 - See "Modify Category" [📖 P81].
 - The category can be set later.
- 3 Select and confirm on **"VPS/PDC"**.
 - See "VPS/PDC Recording" [📖 P55].
- 4 Select **"WEEKLY/DAILY"** to set the recording frequency.
 - See "Weekly/Daily Timer Programming" [📖 P94].
- 5 Select **"REC MODE"** to set the recording mode.
 - See "Recording Mode" [📖 P92].

5 Select "OK".

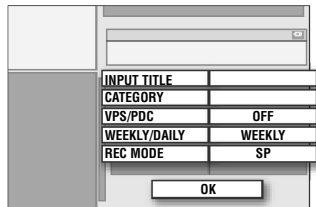
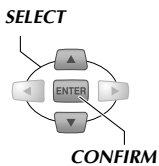

- If timer programmes overlap, a warning message will be displayed.

6 Select "EXIT".

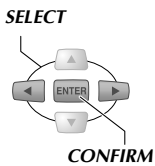

To continue with other timer programmings, select **"CONTINUE"**, then repeat step **2–6**.

- Press **STANDBY/ON** to turn off when not performing other operations.

To timer record using VPS/PDC

7 Press VPS/PDC.

- This unit turns off automatically and enters into recording standby mode.
-  lights up on the front display panel indicating that VPS/PDC recording is activated.

When programming content overlaps

- When completing the setting, if a message on programme overlap is displayed, cancel the timer programme, or change the programmed time, etc.
- See "Checking, Changing or Cancelling a Timer Programme" [📖 P57].

(Warning message on programme overlap)

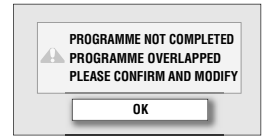

NOTE:

- If you do not cancel the timer programme or change the programmed time, the programme whose start time is earlier will be recorded first until it ends, then the next programme will be recorded unless it has ended.

Calendar Timer Programming



- ▶ You can set timer programme by specifying the date and time.
- ▶ You can programme up to 16 programmes, including other programmes, within 1 year.

PREPARATION:

- Load a recordable disc when recording to a DVD disc. [P12]

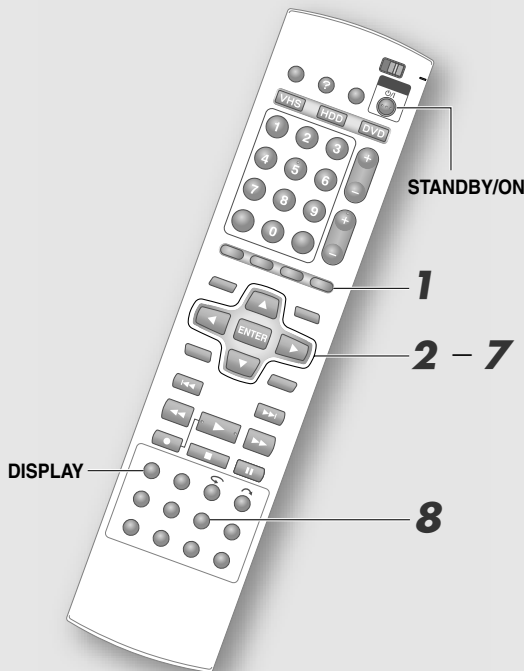

IMPORTANT:

- Timer programming of an external receiver cannot be set using the programme navigation.
- Timer programming on the VHS is not possible.

NOTES:

- If there is inactivity for approximately 1 minute during setting, the settings will be cancelled and the screen will return to the broadcast screen.
- To discontinue programming, press **PROG** and select "EXIT".
- See "Timer Recording" [P97].

1 Display the programme navigation screen.



2 Select "CALENDAR PR.".



3 Select the date to programme.



- To display the calendar for the next month, press the **Selection Key** (▽) from the last week.
- Dates that cannot be selected will be in black.

4 Set recording options (1) for timer programming.

- 1 Select "RECORD TO", then select the recording deck.
- 2 Select "START", then set the time.
 - For time setting, press and hold the **Selection Keys** (△▽) to change in 30-minute intervals.
- 3 Select "STOP", then set the time.
- 4 Select "TV PROG", then select the receiving channel.
- 5 Select "CONFIRM".



5 If necessary, set recording options (2) for timer programming.

- 1 Select "INPUT TITLE" to enter the title name.
 - See "Creating Programme Title" [P82].
 - The title can be set later.

2 Select “CATEGORY” to set the category.

- See “Modifying Thumbnail/Category” [P80].
- The category can be set later.

3 Select and confirm on “VPS/PDC”.**4 Select “WEEKLY/DAILY” to set the recording frequency.**

- See “Weekly/Daily Timer Programming” [P94].

5 Select “REC MODE” to set the recording mode.

- See “Recording Mode” [P92].

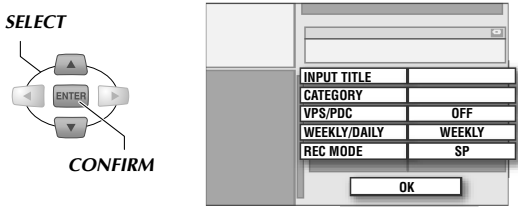
6 Select “OK”.

- If timer programmes overlap, a warning message will be displayed.

7 Select “EXIT”.

To continue with other timer programmings, select “CONTINUE”, then repeat step **2–7**.

- Press **STANDBY/ON** to turn off when not performing other operations.

To timer record using VPS/PDC**8 Press VPS/PDC.**

- This unit turns off automatically and enters into recording standby mode.
- lights up on the front display panel indicating that VPS/PDC recording is activated.

VPS/PDC Recording

Information to enable accurate timer recording is sent along with video and audio signals from some broadcast stations. These services are called VPS (Video Programming System) and PDC (Programme Delivery Control).

■ To verify the reception of VPS/PDC signals**① Press *DISPLAY* for 5 seconds.**

- “VPS/PDC” on the front display panel blinks. The blinking stops when signals are received. When the blinking does not stop, signals cannot be received.

② Press *DISPLAY* again.

- The front display panel returns to its usual display.

IMPORTANT:

- Pressing **VPS/PDC** will turn this unit off immediately.
- Be sure to press **VPS/PDC** after completing the timer programming procedure to activate the VPS/PDC recording function.
- The programme listing data download is given priority from 03:00 to 04:30, and VPS/PDC recording cannot be performed properly. Set “VPS/PDC” to “OFF” if performing timer recording at this time.

NOTES:

- (VPS/PDC recording indicator) on the front display panel will blink when **VPS/PDC** is pressed in the following cases.
 - The clock is not set.
 - Timer programming is not set.
- For calendar timer programming, set the start time correctly using the official time. Recording will not be performed if a wrong time is set.
- The following cannot be done during timer recording.
 - Switching between HDD, DVD and VHS.
 - Display of Setup Menu, Library Database Navigation, and Editing screens.
- VPS/PDC does not function during DVD playback even if **VPS/PDC** is pressed.

When programming content overlaps

- When completing the setting, if a message on programme overlap is displayed, cancel the timer programme, or change the programmed time, etc.
- See “Checking, Changing or Cancelling a Timer Programme” [P57].

(Warning message on programme overlap)



Changing or Cancelling a Timer Programme (The GUIDE Plus+ System)



► Changing or cancelling a timer programme can be done on the “Schedule” area screen.

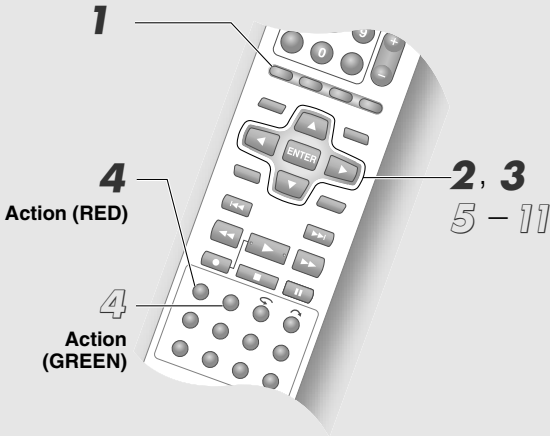

If changing

4 Change.
ON SCREEN

5 Change the recording date.

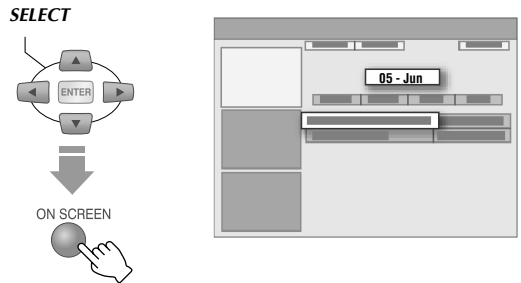

- Can also be entered using the **Number Keys**.

6 Change the recording start time.

7 Change the recording end time.

8 Change the recording channel.

- Can also be set from the channel (mosaic) screen.

9 Change the name for the timer programme settings.

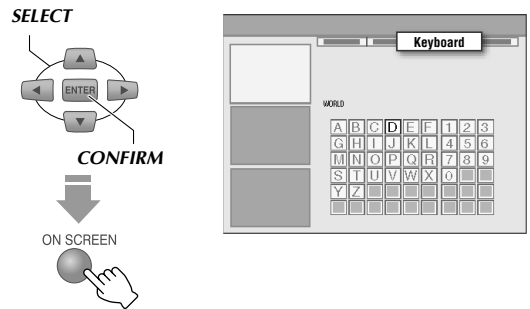

- The Virtual Keyboard screen will be displayed.

10 Select and confirm on “Save”.



11 Set the recording deck, recording mode, etc.

See “If setting the recording deck, recording mode, etc.” [P49].

1 Access the GUIDE Plus+ system.



2 Select “Schedule”.

3 Select the timer programme that you wish to cancel or change.

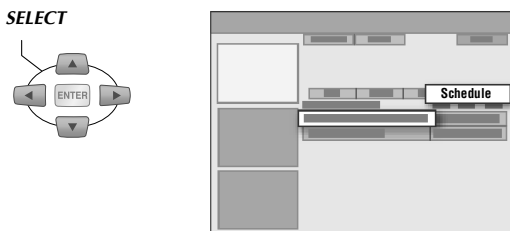

- Select the tile on the right of the timer programme.

When cancelling the timer programme

4 Cancel.



Checking, Changing or Cancelling a Timer Programme



- ▶ Timer programmes can be changed or cancelled.

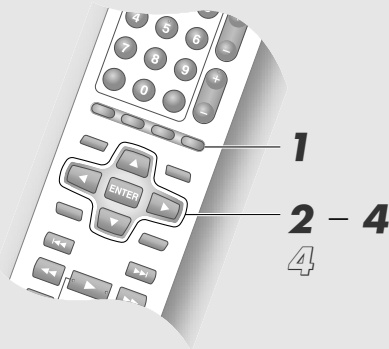

1 Display the programme navigation screen.



2 Select "PROGRAMME LIST" or "CALENDAR LIST".

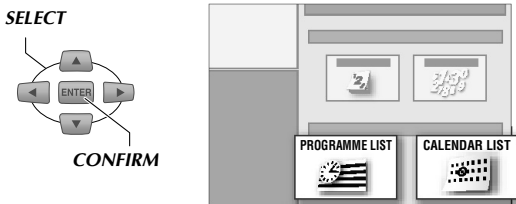

3 Select a timer programme.

If "PROGRAMME LIST" is selected

1 Select a programme.

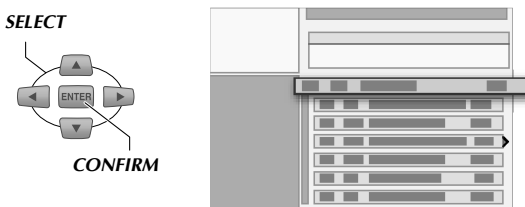

- Pressing the **Selection Key** (▷) will display the weekly/daily timer programme's recordable time limit. Timer programmes with (!) will display the recordable time limit. Timer programmes with (X) cannot be recorded.

If "CALENDAR LIST" is selected

- 1 Select the programmed date.
- 2 Select a programme.



When cancelling the timer programme

4 Select "CANCEL".



- When a timer programme set using the GUIDE Plus+ system is deleted, it will also be from the "Schedule" list of the GUIDE Plus+ system.

When changing the timer programme

4 Select "MODIFY".

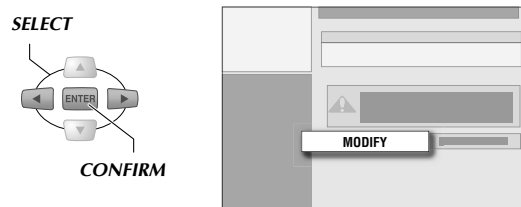

Proceed to change the programmed settings. Perform "Calendar Timer Programming" [P54, 55], step 4 – 7.

- If the weekly/daily timer programme is carried out at least once, the recording deck, channel, weekly/daily setting, and the recording mode cannot be changed.

Playing VHS Tapes



- ▶ Play back programmes recorded on a VHS tape. Tapes recorded in S-VHS format can also be played. However, it will not be of the original S-VHS high image quality. ("SQPB (S-VHS Quasi Playback) function" [P14])

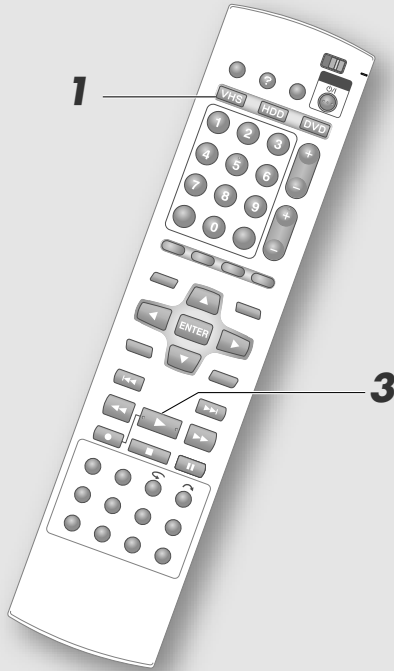

NOTES:

- If the end of the tape is reached during playback or fast-forwarding, it will be rewound automatically.
- Set the following to adjust to the best picture according to the tape in use. **Setup Menu** "PICTURE CONTROL" = "AUTO" [P115] [40]
- The picture quality can be set as desired.
- Automatically stops if pausing continues beyond 5 minutes.
- Set the following when recording MESECAM signals or playing MESECAM tapes. **Setup Menu** "COLOUR SYSTEM" = "MESECAM" [P115] [41]

To eject the tape

- Press **▲** on the unit.

1 Select the playback deck.





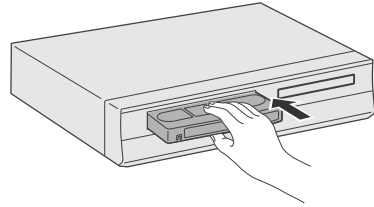



2 Load a tape.



3 Start playback.



Possible operations during playback

Playback		<ul style="list-style-type: none"> • Resumes normal playback when pressed during pause or forward search.
Stop		<ul style="list-style-type: none"> • Stops playback and displays the broadcast screen.
Pause		<ul style="list-style-type: none"> • Pauses playback and displays a still image. Each press of the button advances one frame at a time. • Holding for more than 2 seconds during playback activates slow motion playback (frame-by-frame playback).
Forward Search		<ul style="list-style-type: none"> • Switches between the following speeds with each press. SP (Standard) +5x speed ↔ +11x speed LP (2x) +11x speed ↔ +31x speed
Reverse Search		<ul style="list-style-type: none"> • Performs reverse playback (-1x speed) if pressed, then switches between the following speeds with each press. SP (Standard) -5x speed ↔ -11x speed LP (2x) -11x speed ↔ -31x speed • Press PLAY to return to normal playback.
Skip Search		<ul style="list-style-type: none"> • Skips forward for approximately 30 seconds and resumes playback.
One Touch Replay		<ul style="list-style-type: none"> • Skips back for approximately 7 seconds and resumes playback.

Forward/reverse searching

While stopped



Forward search.



Reverse search.

- To stop forward/reverse search, press **STOP/CLEAR**.
- In order to protect the tape, it will take some time for the tape to stop after **STOP/CLEAR** is pressed during forward/reverse search.

Playing the tape repeatedly

Plays back from the beginning to the end of the tape 100 times repeatedly.



Press and hold for more than 5 seconds.

- To quit halfway, press **STOP/CLEAR**.
- During repeat playback, the “” indicator will light up on the front display panel.
- Playback or repeat playback is not possible for tapes recorded in 5x (SEP) mode.

To play the tape after rewinding

Rewind the tape, and it will play automatically when rewinding is completed.



Within 2 seconds

Index search

For VHS tapes, index signals (VISS signals) are marked at the beginning of each recording. Index searching of programmes can be done using those signals. Up to 9 indexes can be specified in either direction. It is convenient when you know the index at which the programme you wish to watch is recorded.





OR

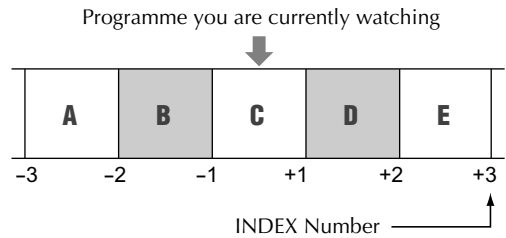

Specifying the index number



(Example)

- To index the next programme : Press  once.
- To index the current programme : Press  once.
- To index the previous programme : Press  twice.

Watching While Recording



- ▶ While the HDD or DVD-RAM is recording a programme, you can watch a recorded portion of a programme even before recording ends. (Live Memory Playback)
- ▶ During recording, you can watch another programme that has been recorded. (Simultaneous Recording and Playback)

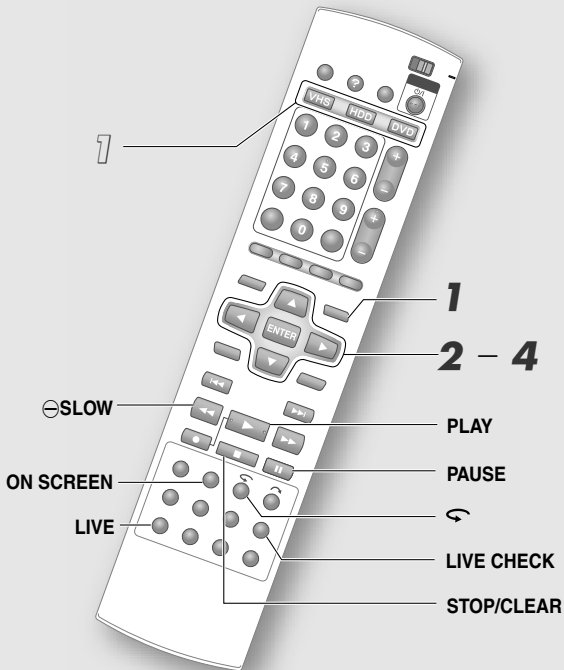

IMPORTANT:

- For DVD-RAM, Live Memory Playback cannot be performed within approximately 30 seconds from the start of recording.
- When using Live Memory Playback during timer recording, the unit remains turned on and playback continues even after recording ends.
- If timer recording starts during Live Memory Playback on DVD-RAM, the recording destination will be the HDD even if recording on DVD-RAM has ended. ("Relief Recording" [P97])
- It is impossible to perform ITR during Live Memory Playback. Stop playback, then perform ITR settings. ("Possible operations during recording" [P39])
- Live Memory Playback and Simultaneous Recording and Playback cannot be performed while recording from the DV input or recording in DV mode.

Programme Playback during Recording (HDD & DVD-RAM)

Example

Recording a programme from 21:00 to 23:00, return home at 22:00 and watch the programme from the beginning.

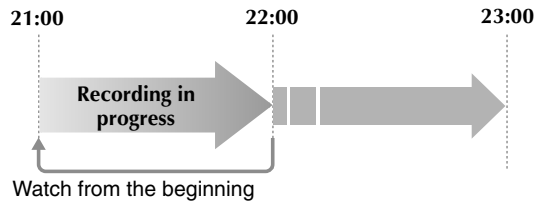

1 Access the Library Database Navigation screen during recording.

(On-screen display for DVD)

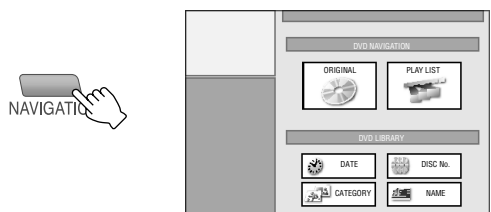

2 Select "ORIGINAL".



3 Select the programme that is currently being recorded.



Programme currently being recorded (the very last programme)

4 Select "BEGINNING".

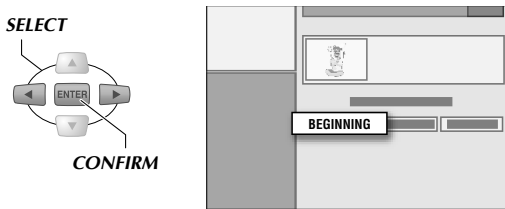

- See "Usable Buttons during Playback (HDD/DVD)" [P44].

To stop Live Memory Playback

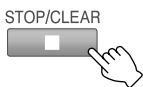

- Exits Live Memory Playback, and the image currently being recorded is displayed.

Operating status during Live Memory Playback

To display the operation information, for example, on the HDD.

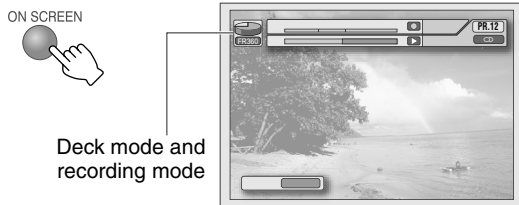

To display the image being recorded.

Image during Live Memory Playback

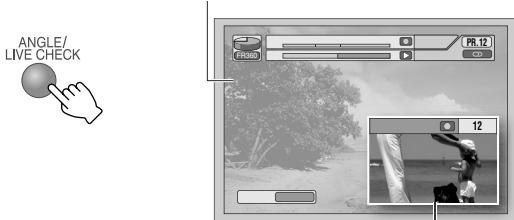

Image currently being recorded

To display the broadcast image.



- Exits Live Memory Playback, and the image currently being recorded is displayed.

Live Memory Playback can also be performed in the following ways

With HDD/DVD-RAM

- Press . Skips back for approximately 7 seconds and resumes playback.
- For DVD-RAM, the initial press skips back for approximately 30 seconds, then resumes playback. (One Touch Replay)

With HDD

- Press **SLOW** . While doing reverse searching, locate the point to start playback from, then press **PLAY**.
- Press **PAUSE**. Press **PLAY** to continue playback. You can resume playback of a programme you are watching while recording, from the point where you have paused. (Resuming Playback)

Play Back Other Programmes While Recording (HDD, DVD-RAM/-RW/-R & VHS)

1 Select the playback deck during recording.



OR



OR

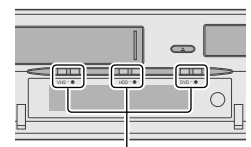

Playback deck's LED lights up

- If the playback deck happens to be the recording deck, setting is not required.

2 Start playback.

- Perform the same procedures as for "Programme Playback during Recording (HDD & DVD-RAM)" [P60]. In this case, select the programme that you wish to watch.
- For VHS, press **PLAY**.
- Playback on the VHS is not possible while recording on the VHS.
- Other than DVD-RAM discs, playback on the DVD is not possible while recording on the DVD.

Watching DVD Videos



- ▶ Commercially available DVD Videos can be played back.
- ▶ Setting the audio, subtitle language and angle (camera) during playback.

PREPARATION:

- Switch **TV/DVD** on the remote control to **DVD**.

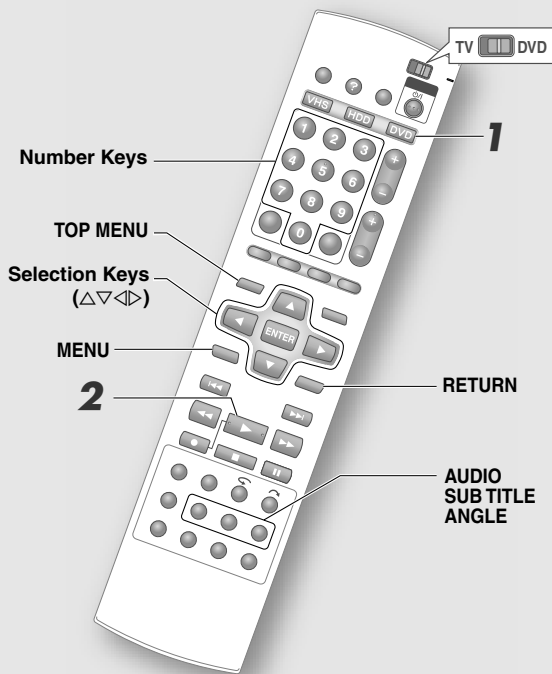

Watching DVD Videos

1 Select DVD, and load a disc.



2 Start playback.



Playback will begin, or the menu screen will be displayed. Select a menu item if the menu screen is displayed.

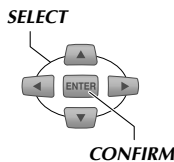

To display the menu screen during playback, press **TOP MENU** or **MENU**.



OR

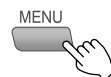

- See the following pages.
 “Usable Buttons during Playback (HDD/DVD)”
 [📖 P44]
 “Playback Setting Menu Operations” [📖 P106]
- For details on menu selection or disc playback method, refer to the instruction manual of the disc you are using.

Audio, Subtitle and Angle Selection

Selecting the audio language (DVD Video, Video CD)

- For Video CDs, the audio will be switched.

During playback

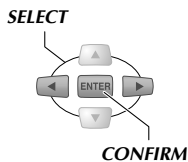

On-screen Display

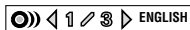

Selecting the subtitle language

During playback

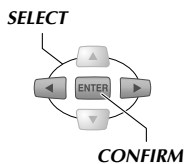
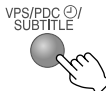

On-screen Display

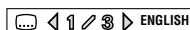

Selecting the image angle (camera) (DVD Video)

During playback

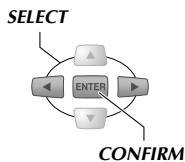

On-screen Display

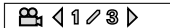

- Depending on the disc, the subtitle or audio language may not switch even if **SUBTITLE** (or **AUDIO**) is pressed. At times like this, switch using the disc menu.
- When appears on the TV screen, either the disc does not support that function, or the change of setting is prohibited.

Watching Video CDs (PBC Function)

Playing back Video CDs that supports PBC (Playback Control) function.

PREPARATION:

- Switch **TV/DVD** on the remote control to **DVD**.

① *Select DVD, and load a disc.*



- Playback may also begin automatically when the disc is loaded. In this case, press **RETURN**.

② *Display the menu screen.*



- When "PREVIOUS" / "NEXT" is displayed on the menu screen, press to browse the pages.

③ *Select and play back the programme that you wish to watch.*

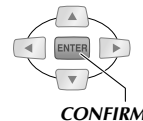
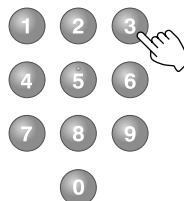

- You can also select by pressing **PLAY**.
- "PBC" will be displayed on the front display panel when playback begins.
- You can display the menu screen during playback by pressing **RETURN**.

■ To play back without activating the PBC function

Press the **Number Keys** while stopped, select the track that you wish to play, then press **ENTER**.

Progressive Scan Output



- ▶ By outputting progressive scan signals, DVD Videos and more can be viewed with high image quality.
- ▶ Progressive scan images can be viewed on the VHS via the [COMPONENT VIDEO OUT] terminal.

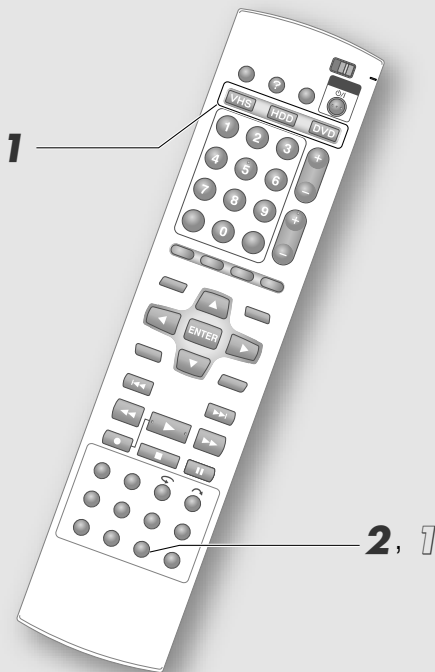

IMPORTANT:

- Use this function if connected to a TV compatible with progressive scan using the component video terminal.
- When setting to progressive scan output on the VHS, check that the HDD or DVD has stopped.

Enabling Progressive Scan Output

1 Select the playback deck.

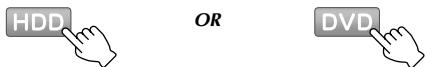

- The current output format will be displayed on the front display panel.

2 Press **PROGRESSIVE SCAN** for more than 3 seconds.



- When progressive scan output is active, the **P** mark will light up on the front display panel.

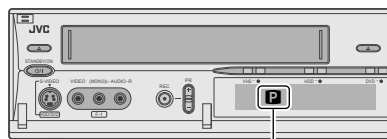

P mark lights up

Disabling Progressive Scan

1 Press **PROGRESSIVE SCAN** for more than 3 seconds.



- **P** mark on the front display panel lights off.

To enable component output for VHS

- 1 Press **HDD** or **DVD**.
- 2 **Setup Menu** "L-1 OUTPUT" = "COMPONENT" [**P114**] **36**
- 3 Set the TV compatible with progressive scan images to its **COMPONENT** input mode.
- 4 Press **PROGRESSIVE SCAN** for more than 3 seconds.
 - The **P** mark lights up on the front display panel.
- 5 Press **VHS**.
 - The VHS lamp on the unit lights up.
- 6 Press **PROGRESSIVE SCAN**.
 - "COMP OFF" will be displayed on the front display panel for 5 seconds.
- 7 Press **PROGRESSIVE SCAN** again before "COMP ON" lights off.
 - "COMP ON" is displayed and the **P** mark lights up on the front display panel.
 - The VHS progressive image will be output from the [COMPONENT VIDEO OUT] terminal.
 - If **PROGRESSIVE SCAN** is pressed again while "COMP ON" is displayed, "COMP OFF" will be displayed, and VHS component output will be disabled.

Playing Back MP3 & JPEG Files

HDD	DVD-RAM	DVD-RW-VR	DVD-RW-VIDEO	DVD-R-VR	DVD-R-VIDEO	DVD-VIDEO	V-CD	C D	JPEG MP3	VHS
-----	---------	-----------	--------------	----------	-------------	-----------	------	-----	----------	-----

- ▶ Able to play back MP3 audio files recorded in CD-R discs, etc. and play back JPEG still images as a slide show.

PREPARATION:

- If a disc contains both MP3 and JPEG files, specify the file for playback using the following setting. **Setup Menu** “MP3/JPEG” [P111] 15

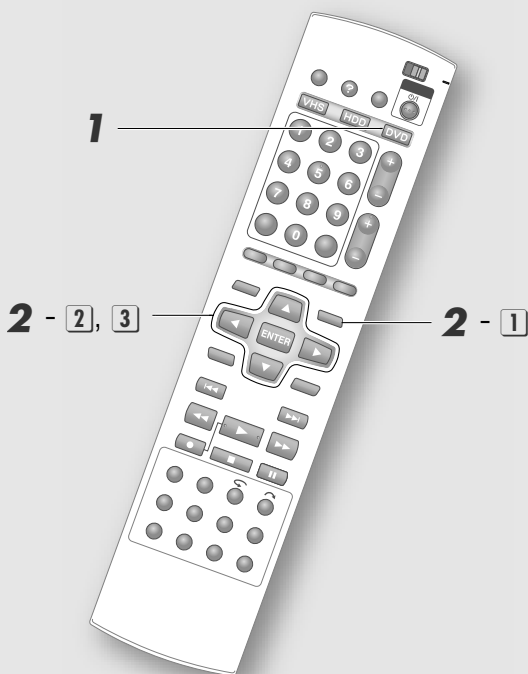

1 Select DVD, and load a disc.



- Check the playable file formats. “About Discs” [P12]

2 Start playback.

1 Display the Library Database Navigation screen.



2 Select “ORIGINAL”.

SELECT

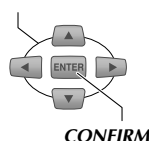

3 Select a file to play back.

SELECT

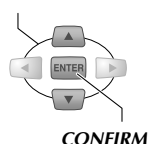

File list

- Plays back from the selected file until the last file.
- Only those files in the same folder will be played back continuously.
- MP3 files will be played back as tracks. The track/total track number being played back is displayed on the top left screen.
- For JPEG files, the display time for slide show can be set. “Display time interval for JPEG or slide show” [P108]
- JPEG files with a resolution of 640 x 480 are recommended. It takes some time to display for those with higher resolution.
- The aspect ratio of the image may appear differently on the TV and computer.

Formatting



- ▶ Formatting will erase all the data. As such, before formatting a recorded disc, make sure the disc does not contain important recordings.
- ▶ Brand new DVD-RAM or DVD-RW discs may also need to be formatted.
- ▶ To use a DVD-R disc in VR mode, format the new disc in VR mode. (It will be in Video mode when not formatted.)

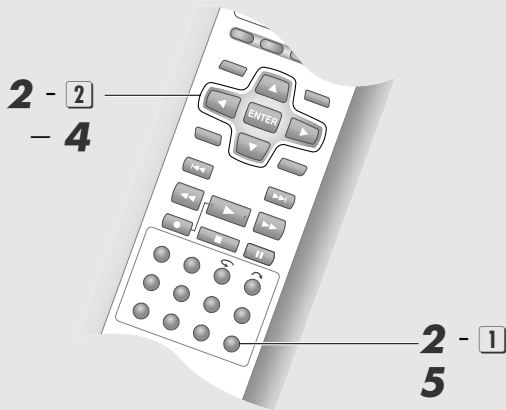

CAUTIONS:

- Never turn off the unit or disconnect the AC power cord while “NOW FORMATTING...” is displayed on the TV screen.
- All the titles on a disc will be deleted once the disc is formatted even if they are protected titles. [P88]
- DVD-R discs can only be formatted once.

1 Load a disc.

2 Select “FORMAT”.

- 1 Access the setup menu.



- 2 Select “HDD/DVD SET UP” → “DISC SET UP” → “FORMAT”.



3 For DVD-RAM

Select “EXECUTE”.

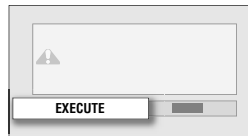

For DVD-RW

Select “VR MODE” or “VIDEO MODE”.



- This screen will not be displayed in the case of a DVD-R disc. Proceed to step 4.

4 Select “EXECUTE”.

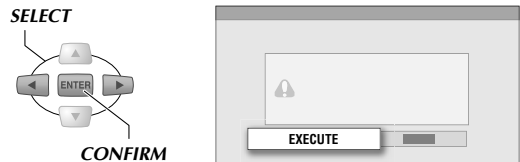

- When formatting a DVD-RW disc, confirm on the mode to be formatted.

If a “COMPLETED” message is displayed,

- Press **ENTER** to return to the setup menu.

5 Exit formatting.



Formatting a new disc

DVD-RAM

- 1 When the disc is loaded, the screen in step 4 is displayed.
- 2 Select “EXECUTE” to format.

DVD-RW

- 1 When the disc is loaded, the screen in step 3 is displayed.
- 2 Select the desired mode and start formatting.

Watching on Other DVD Players (Finalising)



- ▶ To play back DVD-R and DVD-RW discs on other DVD players, perform finalisation. Finalising a Video mode disc results in a DVD VIDEO disc with programme menu. Recording and editing are not possible after finalising.

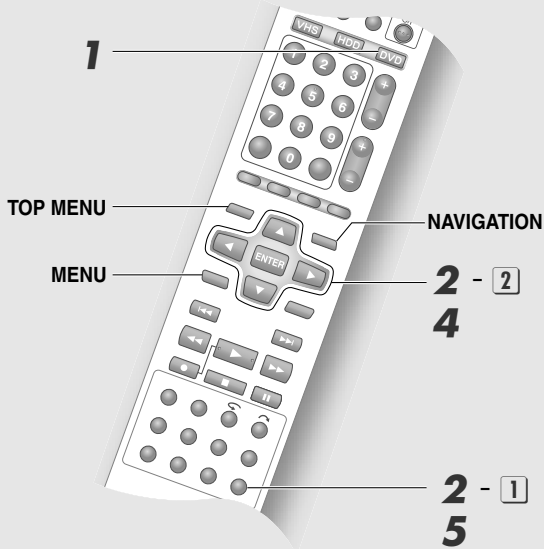

1 Select DVD, and load a disc.



2 Select "FINALISE".

- 1 Access the setup menu.



- 2 Select "HDD/DVD SET UP" → "DISC SET UP" → "FINALISE".



3 Choose a background image for the menu. (Video mode only)

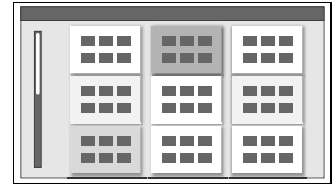
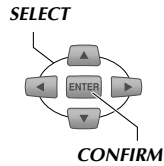

- There are 18 types of background images.
- This step does not apply to DVD-RW/-R (VR mode) discs.

4 Perform finalisation.

- 1 Select "OK".
- 2 Select "OK" again.

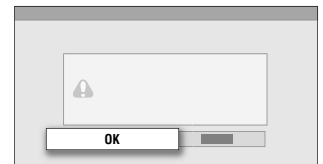
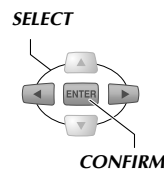

If a "COMPLETED" message is displayed,

5 Exit finalisation.



Playback after finalisation

- Press **TOP MENU** or **MENU** to operate Video mode discs, as with DVD Videos.
- Press **NAVIGATION** to operate VR mode discs.
- Finalised DVD-RW (VR mode) discs can be played back on VR mode compatible devices.
- Finalised DVD-R (VR mode) discs can be played back on DVD-R (VR mode) compatible devices.

To cancel finalisation

- 1 Load a finalised DVD-RW disc.
 - It is not possible to cancel the finalisation of a DVD-R disc.
- 2 Access the setup menu, select and confirm on "HDD/DVD SET UP" → "DISC SET UP" → "CANC. FINALIS.".
- 3 Select and confirm on "EXECUTE" on the confirmation screen.
- 4 Press **SET UP** to exit.

Dubbing

- ▶ Two-way dubbing between HDD, DVD and VHS tape is possible with this single unit. Or simply use the **ONE-TOUCH EXPERT DUB** button on this unit to dub an entire VHS tape exactly to a DVD disc. Dubbing can be done from an external DV camcorder to the HDD or DVD. Refer to the following content for reference during dubbing.

Dubbing source	Dubbing deck	Type	Copying recording information (*1)	Dubbing copy-once titles	Play list dubbing (*2)	Bit-Rate optimiser (*4)	Auto blank-cut dubbing (*5)	Auto title creation (*6)
HDD	DVD	High Speed	✓	✓	✓ (*3)			
		Just	✓	✓	✓	✓		
		Manual	✓	✓	✓	✓		
	VHS				✓			
DVD	HDD		✓					
	VHS							
VHS	HDD/DVD	Entire					✓	✓
		1 programme					✓	
VHS	DVD	Just					✓	✓
DV camcorder	HDD/DVD							

*1 Recording Information: Thumbnails, recording date and time, and channels.

- The play list will be dubbed as one programme.
- Play lists with copy-once images cannot be dubbed.

*2 Play list: Data where only required parts from recorded programmes can be viewed.

- The play list will be dubbed as one programme.
- Play lists with copy-once images cannot be dubbed.

*3 When dubbing play list from the HDD to the DVD-RW/-R (Video mode) discs, dubbing will be performed in the normal speed even if high speed dubbing is selected.

*4 Bit-Rate Optimiser

Optimises the overall bit rate for recording. Scenes with rapid movement are recorded with high bit rates, while scenes with slow movement are recorded with low bit rates, thereby resulting in better picture quality.

*5 Auto Blank-Cut Dubbing

When dubbing from VHS, if there are blanks of more than 2 seconds on the VHS tape, the HDD/DVD will enter into pause mode. Dubbing will resume once recorded part is detected. This prevents useless recordings.

*6 Auto Title Creation Dubbing

When dubbing from the VHS tape, if there are multiple index signals (VISS signals) within a tape, a title (programme) per VISS signal will be automatically created on the HDD/DVD. During that time, dubbing will stop temporarily.

Recordable Once Only Programmes (Copy-once)

- ▶ Among digital broadcasts, there are programmes whose recording with digital devices is permitted only once for the purpose of copyright protection. To record such programmes to a DVD disc, use a CPRM-compliant disc.
- ▶ CPRM (Content Protection for Recordable Media) refers to the technology that enables the recording of copyright-protected “copy-once” programmes.

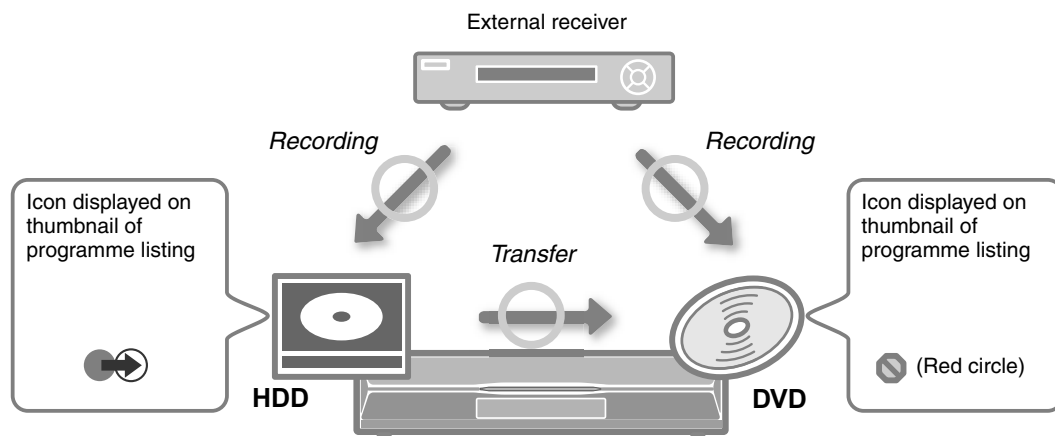

- To record to DVD, use a CPRM-compliant DVD-RAM or DVD-RW/R (VR mode) disc. Formatting may be necessary in order to use DVD-RW/R disc in VR mode. [P66]
- When dubbing from HDD to DVD disc, the data will be transferred while the original data is erased. Data will not be transferred if dubbing is terminated.
- Unable to dub if the play list contains copy-once programmes.

Media	Recording	Dubbing
HDD	✓	✓ Transfers only to CPRM-compliant DVD-RAM and CPRM-compliant DVD-RW/R (VR mode) disc.
CPRM-compliant DVD-RAM	✓	
CPRM non-compliant DVD-RAM		
CPRM-compliant DVD-RW (VR mode)	✓	
CPRM non-compliant DVD-RW (VR mode)		
DVD-RW (Video mode)		
CPRM-compliant DVD-R (VR mode)	✓	
CPRM non-compliant DVD-R (VR mode)		
DVD-R (Video mode)		

Dubbing programmes recorded in DV mode

- Cannot be high speed dubbed.
- Dubbing will be performed using re-encoding. Intelligent Dual-Pass Encoding is not used.
- Programmes recorded in DV mode and in other recording modes cannot be selected at the same time.

Types of Dubbing

3-Way Dubbing from HDD to DVD



High Speed Dubbing [📖 P72]

High speed dubbing in a flash! Be no longer annoyed with the waiting time for dubbing.

- For example, dubbing a 2-hour programme to a DVD-R disc at 64x speed.
- * In FR480 mode, and when using a 8x high speed compatible DVD-R disc.

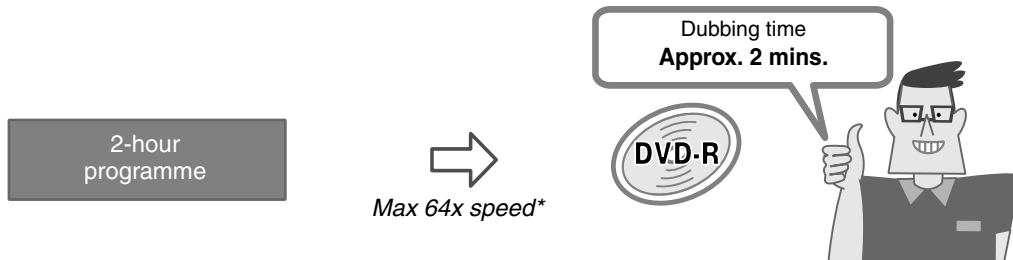

Just Dubbing [📖 P72]

Dubbing that fits exactly to the free space of a DVD disc!

- For example, dubbing to a DVD disc with only 20 minutes disc remaining time.
- Able to record a 30-minute programme exactly to a 20-minute blank space.

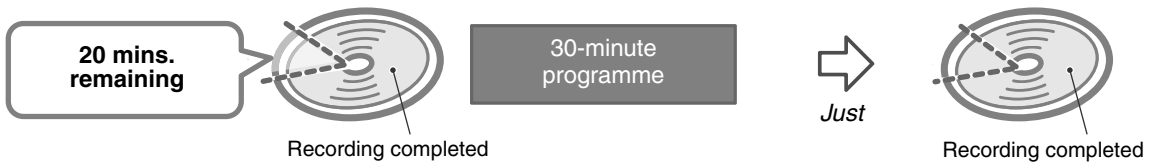

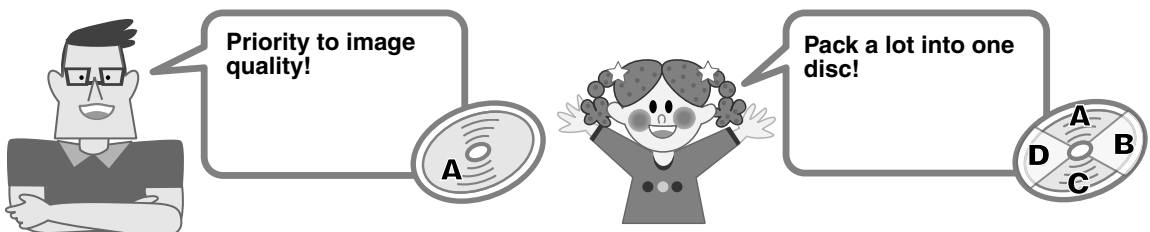

Manual Dubbing [📖 P72]

Set your own desired recording mode for dubbing!

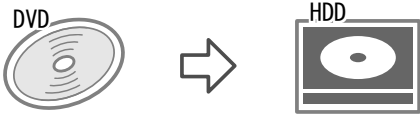

Various Other Dubbing Methods

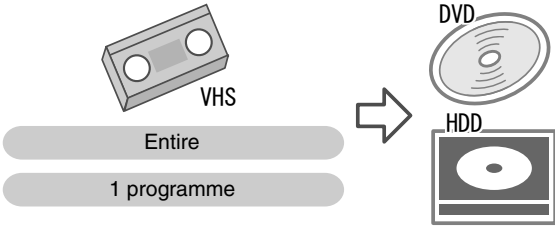
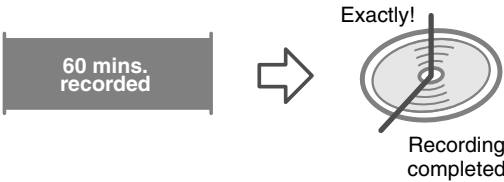
Dubbing from DVD to HDD [📖 P72]	Dubbing from DVD, HDD to VHS [📖 P76]
<p>Able to copy programmes (titles) from the DVD disc with ease.</p> 	<p>Able to copy programmes from the HDD or DVD disc.</p> 
Dubbing from VHS to HDD, DVD [📖 P77]	Just Dubbing from VHS to DVD [📖 P79]
<p>You can dub an entire VHS tape or a programme from it to the HDD or DVD disc.</p> 	<p>Just Dubbing from a VHS tape to fit the free space in a DVD disc can be easily done.</p> 

Dubbing with Other Connected Devices

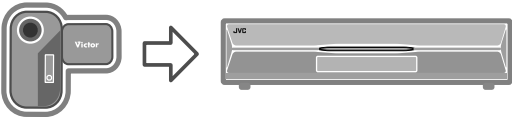
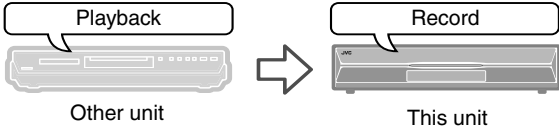
Dubbing from DV camcorder to HDD, DVD [📖 P74]	Dubbing from Video Cassette Recorder (VCR) [📖 P74]
<p>Easy connection with the DV camcorder using just one DV cable! You can even create your very own original DVD disc with ease.</p> 	<p>Connect with an external Video Cassette Recorder (VCR) and record using this unit.</p> 

Dubbing between HDD and DVD Deck



- ▶ You can easily dub from the HDD to DVD disc, and vice versa.
- ▶ There are 3 ways to dub from the HDD to the DVD disc, so you can choose whichever matches your purpose.

PREPARATION:

- Switch **TV/DVD** on the remote control to **DVD**.

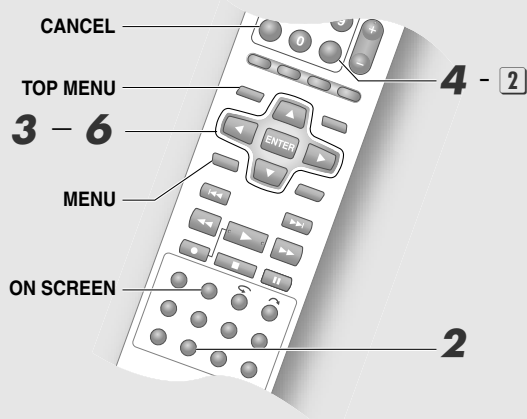

IMPORTANT:

- For high speed dubbing to the DVD-RW/-R (Video mode) disc, the following programmes cannot be high speed dubbed. (They will be dubbed in the normal speed.)
 - Bilingual sound
 - Play list
 - Programmes that are divided, programmes with parts deleted or RetroActive recorded programmes
 - LP or FR155 - FR240 mode recorded programmes
- Programmes or play lists recorded in DV mode cannot be high speed dubbed.
- With Just dubbing, even if there is recording time to spare, it is not possible to perform Just dubbing by raising the recording mode as with changing from SP mode to XP mode.
- When dubbing from a DVD-RW/-R (Video mode) disc recorded on other units to the HDD, finalisation is required.
- It is not possible to dub from +R/+RW discs.

1 Load a disc.

- When dubbing to a DVD disc, load a recordable disc.
- When dubbing to the HDD, load a disc for playback.

2 Display the Dubbing screen.

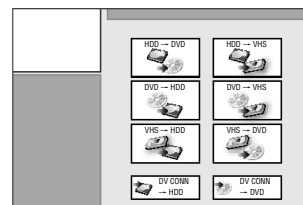
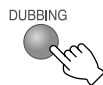

- When "DVD → HDD" is selected, proceed to step 4.

3 Select a dubbing method.

SELECT

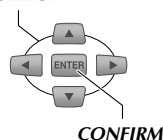

(If "HDD → DVD" is selected)

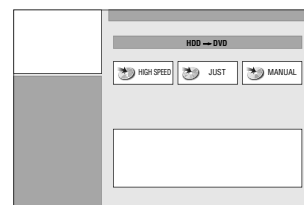

Dubbing from the HDD (hard disk) to a DVD disc

HIGH SPEED	Select when you wish to shorten the dubbing time considerably. DVD-RAM: Max. 3x speed DVD-RW: Max. 4x speed DVD-R: Max. 8x speed <ul style="list-style-type: none"> • Use a high speed compatible disc. • Dubbing may not be performed in the highest speed as shown depending on the disc used.
JUST	Select when dubbing to fill an entire DVD disc, or to fit the available free space exactly.
MANUAL	Select when setting the recording mode for dubbing.

- Select "TITLE" when dubbing from a DVD disc to HDD.

4 Select the programme to be dubbed.

1 Select a programme.

Time bar display

Information display

SELECT

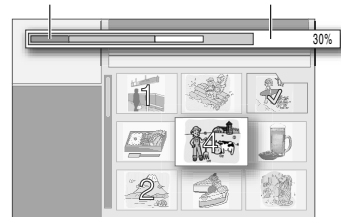
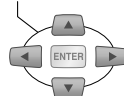

- Programme list screen is displayed in order of recording date and time. Displays in order of name if the dubbing source is HDD.
- Pages can be advanced using **TOP MENU** or **MENU**.

2 Enter into memory.

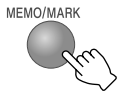

- Repeat step 1 and 2 as necessary. Up to a maximum of 8 programmes can be selected. Programmes recorded in DV mode cannot be selected in combination with programmes in other recording modes.
- To cancel the memory, press **MEMO/MARK** at the programme that has been entered into memory. To cancel all the programmes, press **CANCEL**.

3 Confirm.

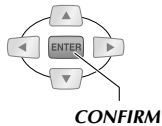

Information display	
HIGH SPEED	Remaining capacity display in percentage (%).
JUST	Total time of selected programmes.
MANUAL	Highest recording mode of selected programmes.
TITLE	Total time of selected programmes.
Time bar display colours	
Deep Green	Used space.
Yellow	Size of selected programmes.
Light Green	Total size of the programmes memorised.
Red	Selected programmes that exceeds the capacity.

5 Set the recording mode. (For "MANUAL" dubbing.)

1 Select "REC MODE" to set the desired mode.

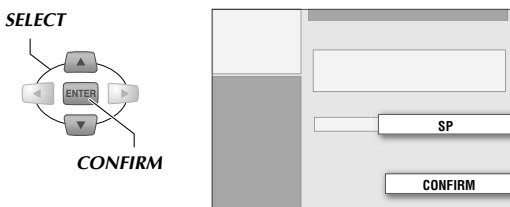

- When setting recording mode, modes with insufficient capacity will not be displayed.

2 Select "CONFIRM".

6 Select "EXECUTE".

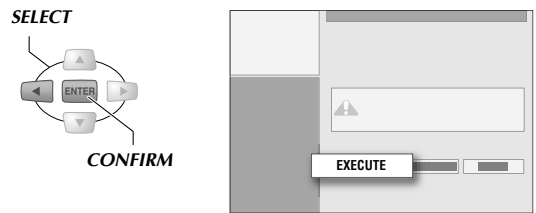

- The "NOW DUBBING" display will be displayed for approximately 5 seconds. (The time duration displayed is an estimate.)

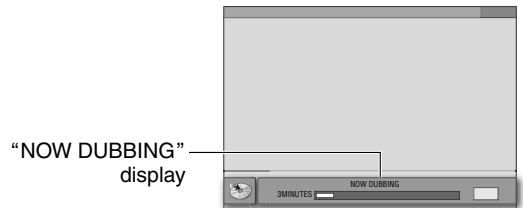

- The "NOW DUBBING" display will be displayed when **ON SCREEN** is pressed.
- The following button operations are possible during dubbing.
PR+/-, AUDIO, HELP
- The broadcast screen is displayed while dubbing is in progress.
- When dubbing coincides with timer recording, see the following page. "Dubbing and timer recording priority" [P97]

To cancel a dubbing that is in progress

1 Press **ON SCREEN** to display the "NOW DUBBING" display.

2 Press **ENTER**.

3 Select "CANCEL", then press **ENTER**.

- When dubbing is discontinued, information such as recording date and time; title name will not be properly recorded.
- The disc remaining time will not increase even if you delete the programme that was dubbed before discontinuing the dubbing to DVD-R.

Dubbing from DV Camcorder/Video Cassette Recorder



- ▶ Dubbing can be done from a DV camcorder that is connected to this unit with a DV cable. You can also operate the DV camcorder from this unit's remote control. (On-screen display for DV dubbing)
- ▶ Dubbing images from an external video cassette recorder to a DVD disc, the HDD or a VHS tape.

PREPARATION:

- Switch **TV/DVD** on the remote control to **DVD**.
- See the following page for the connection. "Dubbing from DV Camcorder/Video Cassette Recorder" [P22]

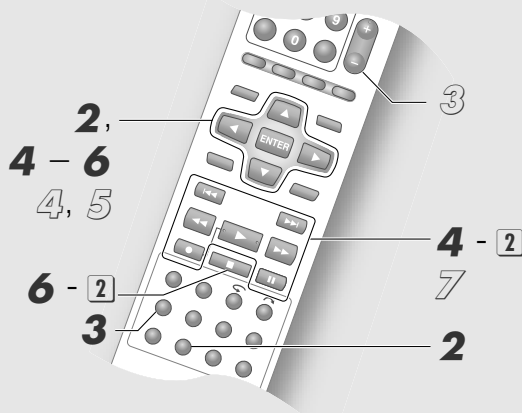

IMPORTANT:

- Certain DV camcorders may not be operable. Operate the camcorder directly.
- Dubbing copyright guarded programmes is not possible.
- It is not possible to operate from the DV camcorder.
- Original DV information such as the recording date and time are not recorded. (During MPEG recording.)
- When a dubbing that is in progress coincides with timer recording, a confirmation screen asking which to give priority will be displayed. Select "CONTINUE" or "EXECUTE".
- To dub from the beginning of the DV tape, start dubbing from the stopped condition in step 4 - 2.
- Chapters (marks) can be automatically inserted. **Setup Menu** "DV AUTO CHAPTERING" = "ON" [P111] 19

Dubbing from DV Camcorder

1 Insert a tape to play on the DV camcorder.

- When dubbing to a DVD disc, load a recordable disc on this unit.

2 Display the Dubbing screen to select the dubbing deck.

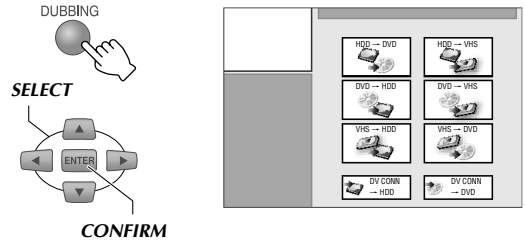

- Select "DV CONN → HDD" to dub to HDD, or "DV CONN → DVD" to dub to DVD.

3 Select the recording mode.

- See "Recording Mode" [P92].

4 Set playback mode on DV camcorder.

1 Select "Remote control switch" ([RECORD] / [M/PAUSE]) to set to [RECORD] .

- Switches each time **ENTER** is pressed.

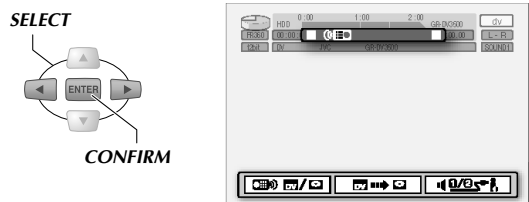

- [RECORD] : Operate this unit.
- [M/PAUSE] : Operate the DV camcorder.

2 Start playback, then pause at dubbing start point.



- You can operate the DV camcorder to play, pause, perform forward search/reverse search; slow motion and frame-by-frame playback, using this unit's remote control. For operating instructions, see "Usable Buttons during Playback (HDD/DVD)" [P44].
- Set to stop condition at portion with no images (for example at the beginning of the tape).
- When dubbing from the pause condition, accurate dubbing can be done by rewinding the tape slightly.

If switching the DV sound

- 3 Select "Sound monitor switch" (), and press ENTER to switch.

SELECT

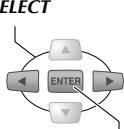



CONFIRM





SOUND1→SOUND2→MIX

- **SOUND1**: Record with normal (original) stereo sound.
- **SOUND2**: Record post-recorded sound in stereo.
- **MIX**: Record both normal stereo sound and post-recording sound. (Post-recording sound is not available for 16 bit recording)

5 Start dubbing.

- 1 Select and confirm on "Auto capture button" ().
 - Select and confirm on  to pause and/or resume dubbing.

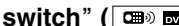
6 End dubbing.

- 1 Select and confirm on "Remote control switch" (), then set to  .
- 2 Stop dubbing.

STOP/CLEAR



PRESS TWICE

Repeat step 4 – 6 if you want to continue dubbing.

Dubbing to a DV device (only programmes recorded in DV mode on the HDD)



Recommended when, after dubbing videos shot using a DV camcorder to the HDD and editing the play list, you wish to store them on a mini DV tape.

- 1 Set the channel to "dv".
- 2 Select and play back the programme recorded in DV mode that you wish to dub from the Library Database Navigation.
- 3 Check if the playback screen appears on the TV connected from the DV device (recording end).
- 4 Pause playback on this unit (playback end) at the dubbing start point.
- 5 Pause recording on the DV device (recording end).
- 6 Start playback on this unit and recording on the DV device simultaneously.
- 7 When dubbing is finished, stop recording on the DV device, then stop playback on this unit.

NOTE:

- This operation is not possible when DVD is selected.

Dubbing from Video Cassette Recorder (VCR)

- See the following page for the connection. "Dubbing from DV Camcorder/Video Cassette Recorder" [ P22]
- This unit's on-screen display can be disabled. Setup Menu "SUPERIMPOSE" = "OFF" [ P113] 

1 (This unit) Load a recordable disc.

2 (VCR) Insert a tape to play.

3 (This unit) Switch to the input connecting the VCR.

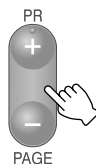

- Select "L-2" or "F-1".
- Press 0 on the remote control to set to "L-2" forcibly.

4 (This unit) Select the recording deck.

5 (This unit) Select the recording mode.

6 (VCR) Start playback.

7 (This unit) Start recording.

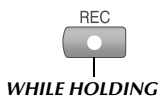

WHILE HOLDING



8 When dubbing is finished, stop recording on this unit, then stop playback on the VCR.

- Dubbing copyright guarded programmes is not possible.
- Recordings made by you, under copyright law, cannot be used without the consent of the right holder other than for personal enjoyment.

When dubbing to Video Cassette Recorder (VCR)

1 Play back on this unit.

2 Record with the VCR.

- For details, refer to the instruction manual of the VCR.

Dubbing from HDD or DVD to VHS



- ▶ Dubbing can be done from the HDD or a DVD disc to a VHS tape.

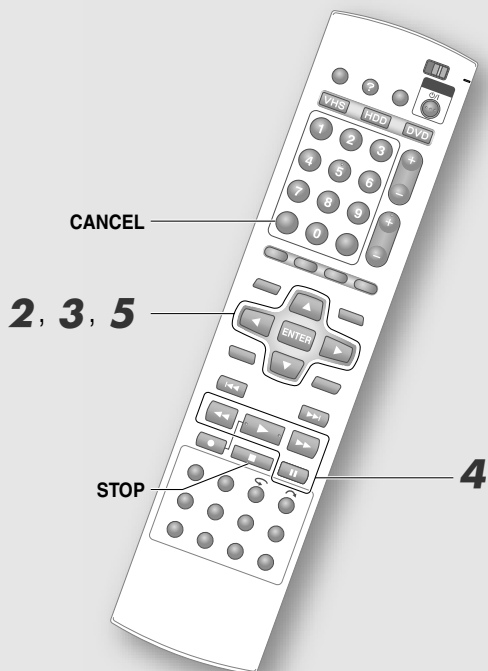

NOTES:

- Select “SP” or “EP” as the recording mode.
- Select “L/R”, “L”, or “R” for the playback sound. If the selected programme is in bilingual, the main audio and sub audio will be recorded to the normal sound of the VHS tape if you select “L/R” under “SELECT SND. MODE”.
- Recording on the VHS tape will be done using the PAL colour system regardless of the setting in the **Setup Menu** “COLOUR SYSTEM” [P115] 41.

1 Load a recordable tape.

- When dubbing from a DVD disc, load a disc to play.

2 Under “Dubbing between HDD and DVD Deck”, select “HDD → VHS” or “DVD → VHS” in step 2, then select the programme to dub in step 4. [P72]

3 Set and confirm the recording.

- 1 Select “SELECT REC. MODE” to set the mode.
- 2 Select “SELECT SND. MODE” to set the playback sound.
- 3 Select “CONFIRM”.



4 Pause the recording.

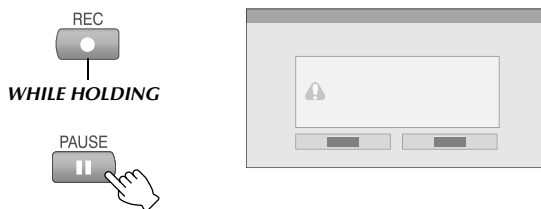

- Locate the recording start point with ◀▶▶▶, then pause the recording.

5 Select “EXECUTE”.

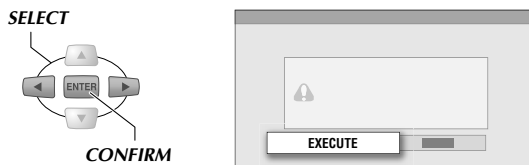

When dubbing ends, the broadcast screen appears automatically after a message is displayed.

To cancel a dubbing that is in progress

- 1 Press **STOP/CLEAR** (■).
- 2 Select “CANCEL”, then press **ENTER**.

Dubbing from VHS to HDD or DVD (Entire)



- ▶ Programmes recorded on a VHS tape can be dubbed in entirety to the HDD or DVD disc.

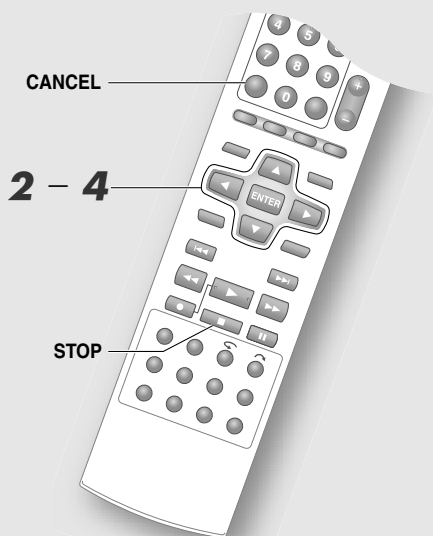

NOTES:

- Select “L/R”, “L”, “R”, or “NORM” for the playback sound.
- Starts dubbing after automatically rewinding the tape to the beginning.
- The tape will be automatically rewound when dubbing ends.
- When the HDD or DVD disc runs out of disc remaining time, the tape will automatically stop at that position and dubbing will cease.
- If there are multiple VISS signals within a tape, separate titles will be created for each VISS signal. (Auto title creation dubbing function)
When titles reach 99 on DVD or 500 on HDD, they will not be created.
- If there are blanks of more than 2 seconds on the VHS tape, the HDD/DVD will enter into pause mode. Dubbing will resume once recorded part is detected. This prevents useless recordings.
- Recording will be done using the colour system set in the **VHS SET UP** menu “COLOUR SYSTEM” [P115] [41] regardless of the setting in the **Setup Menu** “INPUT COLOUR SYSTEM” [P112] [25].

1 Load the tape to play.

- When dubbing to a DVD disc, load a recordable disc.

2 Select “VHS → HDD” or “VHS → DVD” in step 2 of “Dubbing between HDD and DVD Deck”, then select “ENTIRE”. [P72]

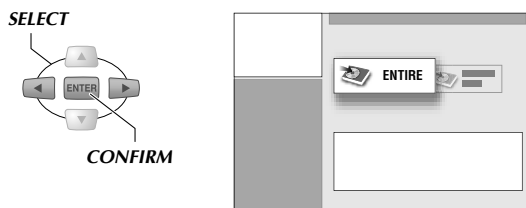

3 Set and confirm the recording.

- “Dubbing from HDD or DVD to VHS”, step 3 [P76].

4 Select “EXECUTE”.

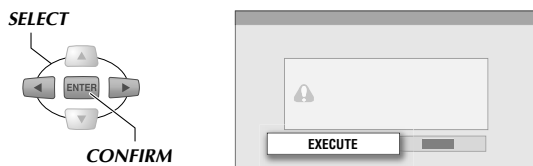

When dubbing ends, the broadcast screen appears automatically after a message is displayed.

To cancel a dubbing that is in progress

- ① Press **STOP/CLEAR** (■).
- ② Select “CANCEL”, then press **ENTER**.

Dubbing from VHS to HDD or DVD (1 Programme)



- ▶ Dubbing only one of the programmes recorded on a VHS tape to the HDD or a DVD disc is possible.

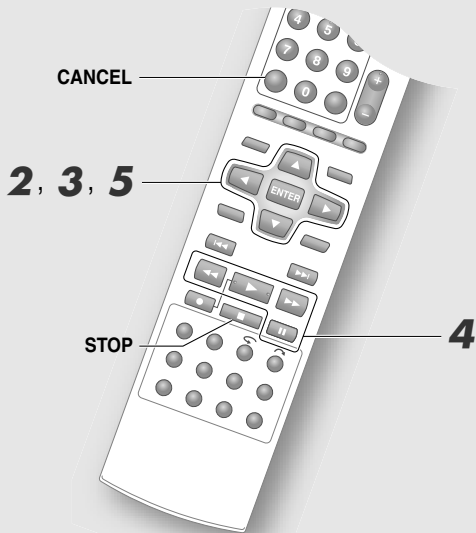

NOTES:

- When the HDD or DVD disc runs out of disc remaining time, the tape will automatically stop at that position and dubbing will cease.

If dubbing to DVD-RW/-R (Video mode)

- For discs in Video mode, switching of audio during playback is not possible. Set to “MAIN” or “SUB” in the Setup menu [P111] 14.
- Recording will be done using the colour system set in the VHS SET UP menu “COLOUR SYSTEM” [P115] 41 regardless of the setting in the Setup Menu “INPUT COLOUR SYSTEM” [P112] 25.

3 Set the recording mode.

- 1 Select the recording mode.

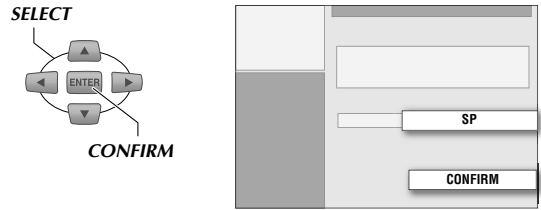

- 2 Select “CONFIRM”.

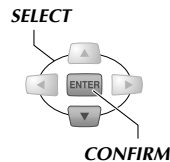

- See “Recording Mode” [P92]

4 Pause playback at the scene that you wish to dub.

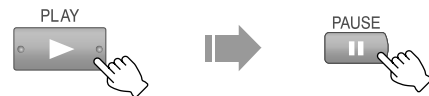

- Locate the recording start point with ◀▶▶▶, then pause playback.

5 Select “EXECUTE”.



If the index signal (VISS) of the VHS is detected, dubbing ends, and the broadcast screen appears automatically after a message is displayed.

To cancel a dubbing that is in progress

- 1 Press **STOP/CLEAR** (■).
- 2 Select “CANCEL”, then press **ENTER**.

1 Load the tape to play.

- When dubbing to a DVD disc, load a recordable disc.

2 Select “VHS → HDD” or “VHS → DVD” in step 2 of “Dubbing between HDD and DVD Deck”, then select “1 PROG.”. [P72]

Just Dubbing from VHS to DVD



- ▶ Just Dubbing from a VHS tape to a DVD disc can be easily done with one touch. The recording time on the VHS tape is automatically calculated, and the recording mode is automatically adjusted to fit the DVD disc's disc remaining capacity exactly.

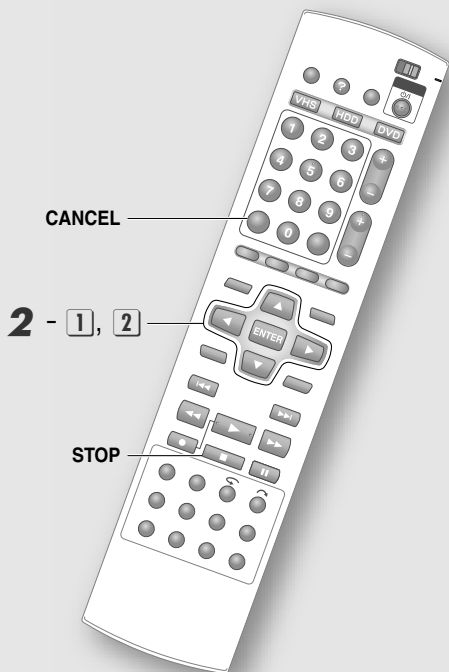

NOTES:

- Select "L/R", "L", "R", or "NORM" for the playback sound.
- Depending on the disc used, the disc remaining time may not be 0:00:00.

It is not possible to dub in the following instances.

- When the DVD disc's remaining capacity is insufficient, or when 99 programmes have been recorded.
- When no VHS tape or DVD disc is loaded.
- When the dubbing screen or setup menu screen is displayed.
- During recording/playback.
- Recording will be done using the colour system set in the **VHS SET UP** menu "COLOUR SYSTEM" [P115] 41 regardless of the setting in the **Setup Menu** "INPUT COLOUR SYSTEM" [P112] 25.

1 Load the tape for playback, and a recordable disc.

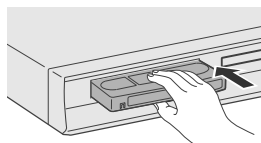

VHS

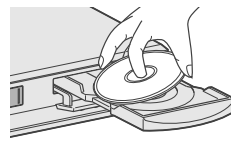

DVD

2 Start dubbing.

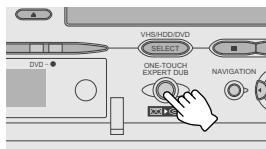

For DVD-RW/-R (Video mode)

Set the playback sound.

- 1 Select the playback sound.

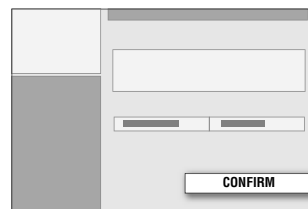
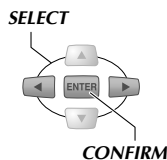

- 2 Select "CONFIRM".

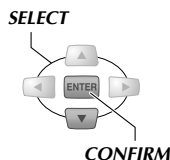

For DVD-RAM, DVD-RW/-R (VR mode)

- Automatically sets to "L/R", and the screen will not be displayed.

When dubbing ends, the broadcast screen appears automatically after a message is displayed.

To cancel a dubbing that is in progress

- 1 Press **STOP/CLEAR** (■).
- 2 Select "CANCEL", then press **ENTER**.

Modifying Thumbnail/Category



- ▶ Thumbnail: The picture on the programme list can be changed to your preferred picture.
- ▶ Category: Can be used for programme searching.
- ▶ You can also modify the thumbnails and category of the play list for HDD as well as DVD-RAM and DVD-RW/-R (VR mode and unfinalised Video mode) discs.

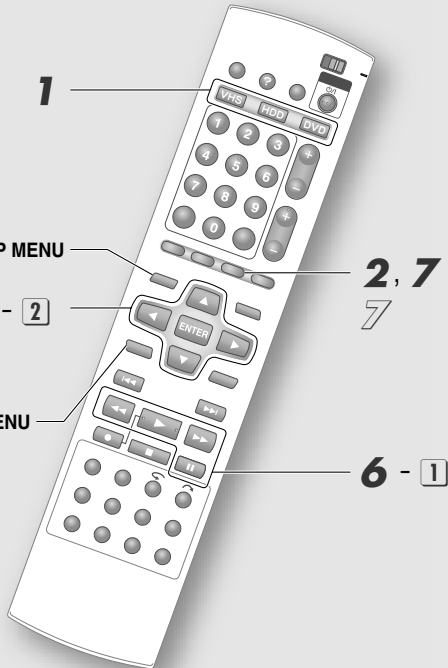

NOTES:

- To modify the play list, you have to create a play list first. [P84]
- Modification on the DVD discs is not possible in the following cases.
 - Title-protected programmes. [P88]
 - Finalised discs. [P67]

1 Select disc.

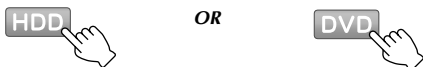

2 Display the Editing screen.

When DVD is selected

- 1 Load a disc.
- 2 Display the Editing screen, then select "MODIFY".

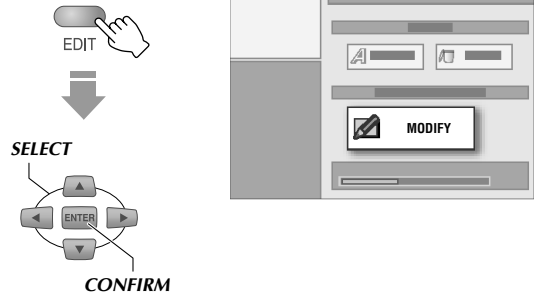

When HDD is selected

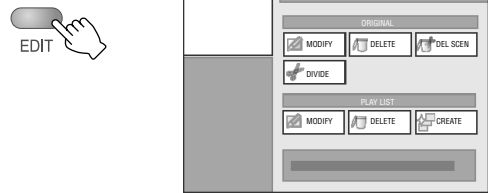

3 Select "MODIFY" under "ORIGINAL".

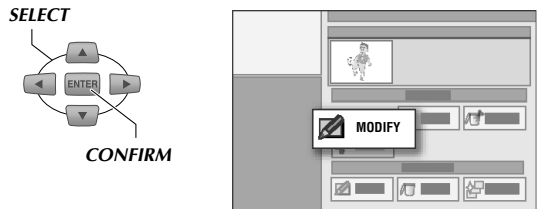

- In the case of play list, select "MODIFY" under "PLAY LIST".

4 Select the programme to be changed.

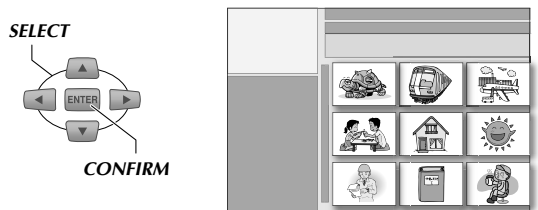

- Pages can be advanced using TOP MENU or MENU.

- To modify the thumbnail, proceed to 5.
- To modify the category, proceed to 5.

Modify Thumbnail

5 Select "INDEX".

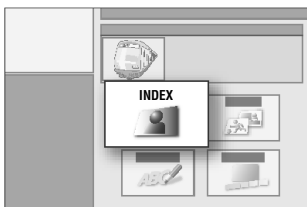
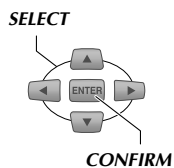

6 Decide on the thumbnail image.

- 1 Start playback, then pause at the desired scene.



- Use SLOW⊖/SLOW⊕ to search for the scene.

- 2 Select "REPLACE".

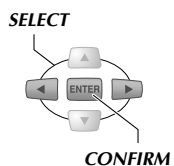

- The new image will be registered.

7 Exit thumbnail modification.



Modify Category

5 Select "CATEGORY".

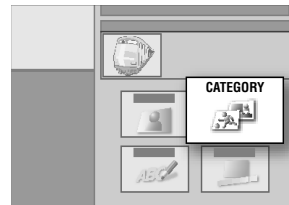
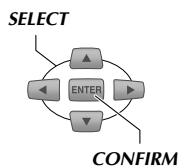

6 Select the desired category.

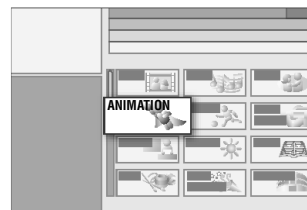
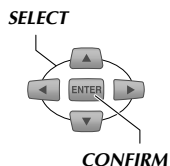

7 Exit category modification.



Creating Programme Title



- ▶ You can name or modify the titles of recorded programmes.
- ▶ You can also name or modify the title name of the play list for HDD as well as DVD-RAM and DVD-RW/-R (VR mode and unfinalised Video mode) discs.

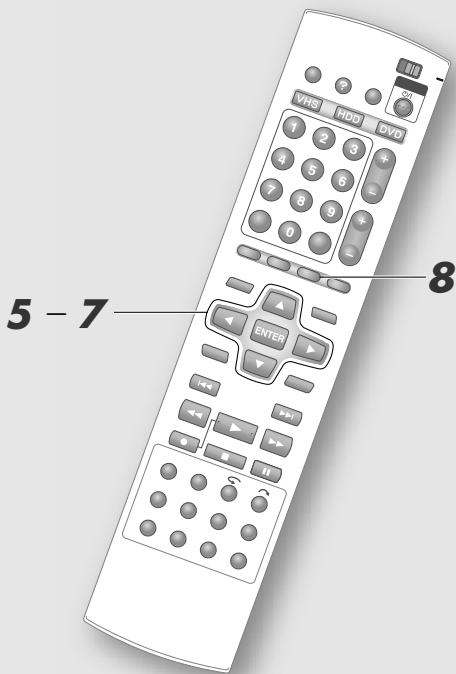

NOTES:

- To name the play list, you have to create a play list first. [📖 P84]
- Modification on the DVD discs is not possible in the following cases.
 - Title-protected programmes. [📖 P88]
 - Finalised discs. [📖 P67]

Perform “Modifying Thumbnail/Category”, step **1 – 4** [📖 P80].

5 Select “NAME”.

SELECT

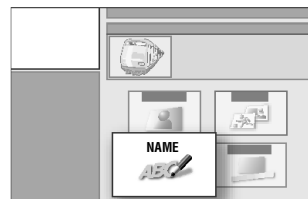
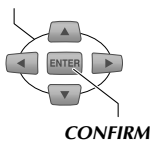

6 Enter the characters.

SELECT

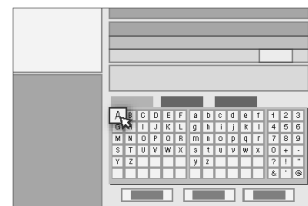
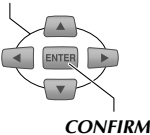

- Select and enter one character at a time.
- There are 3 types of character sets. Select “ALPHABET”, “SYMBOL1”, or “SYMBOL2”.
- Selecting “DELETE” deletes the character before the cursor.
- You can also press **STOP/CLEAR** to delete the character. Press once to delete one character, press and hold to delete all the characters.

7 Select “SAVE”.

SELECT

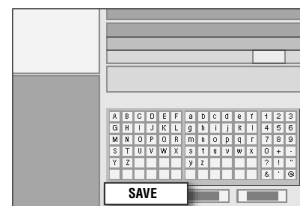
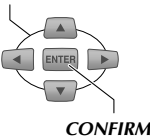

- You can also press **PAUSE** to save.

8 Exit title name creation.



To name a DVD disc

- If you select and confirm on “DISC NAME” in step **2** of “Modifying Thumbnail/Category”, the title entry screen will be displayed. Enter the desired title name.

Creating/Deleting Chapters (Marks)



- ▶ If chapters (marks) are created in the recorded programme, a preferred scene in the programme can be easily located.

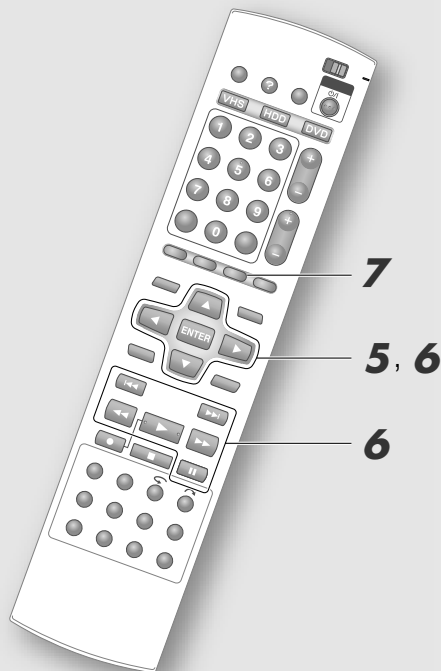

NOTE:

- Modification on the DVD discs is not possible in the following cases.
 - Title-protected programmes. [P88]
 - Finalised discs. [P67]

Perform “Modifying Thumbnail/Category”, step 1 – 4 [P80].

5 Select “CHAPTER”.

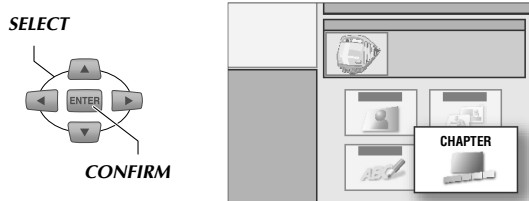

6 Create or erase the chapters (marks).

To create chapters (marks)

- 1 Start playback, then pause at the scene where you want to mark.

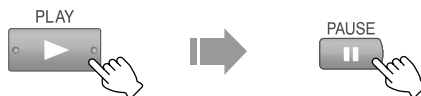

- You can also use SLOW+/SLOW-.

- 2 Select “MARK”.

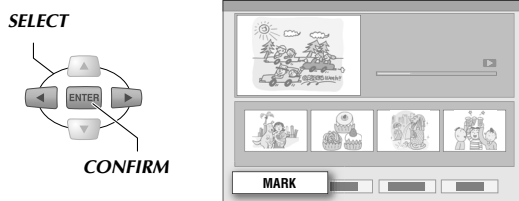

- If a chapter (mark) is created, a chapter image will be added below the screen.
- “RETRY”: Cancels “MARK” or “ERASE”.
- “RETURN”: Returns to the screen in step 5.

To delete chapters (marks)

- 1 Pause playback.

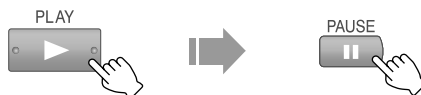

- 2 Move to the mark to be deleted.

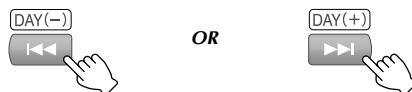

- 3 Select “ERASE”.

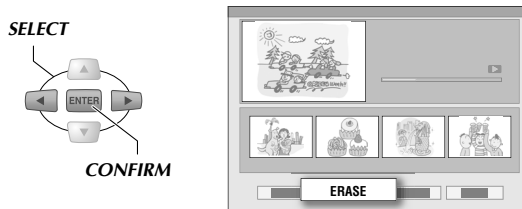

- If a chapter (mark) is deleted, the chapter image below the screen will be cleared.

7 Exit chapter (mark) creation or deletion.



Gathering Favourite Scenes (Play List Creation)



- ▶ A play list is a single programme with a collection of favourite scenes gathered from multiple original programmes. Up to 99 can be created.

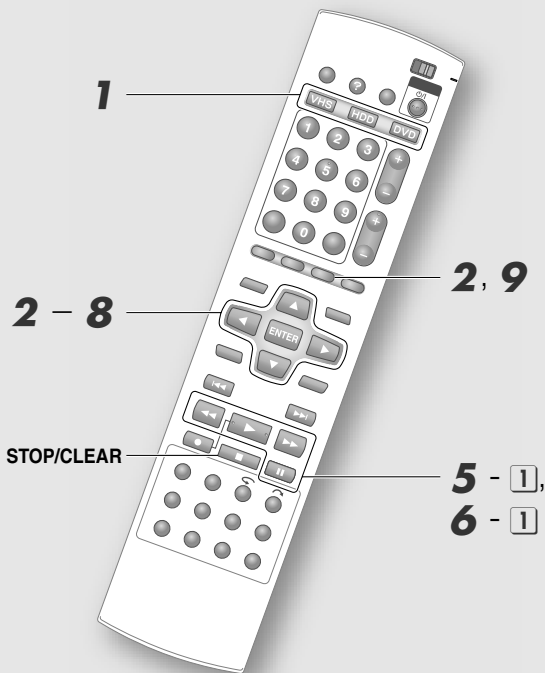

NOTES:

- Play list cannot be created if there is a mixture of programmes recorded in DV mode and other recording modes.
- There may be slight deviation from the points set.

1 Select disc.

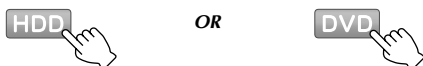

2 Display the Editing screen.

When DVD is selected

1 Load a disc.

2 Display the Editing screen, then select "MODIFY".

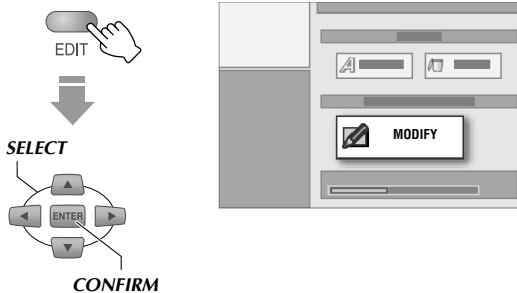

When HDD is selected

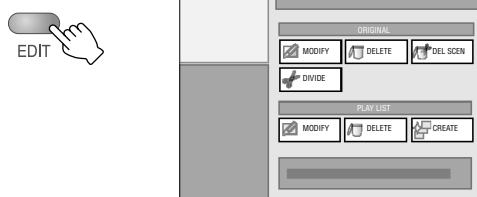

3 Select "CREATE".

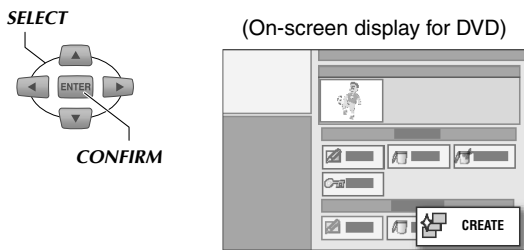

4 Select the programme to be used.

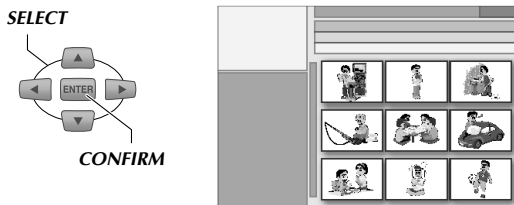

5 Decide on the start point of the scene.

1 Start playback, then pause at the scene where you want the created play list to begin.

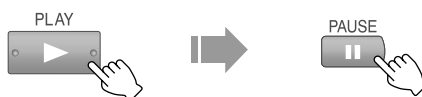

- You can also use SLOW+ / SLOW- to search for the start and end point.

2 Confirm on the start point.

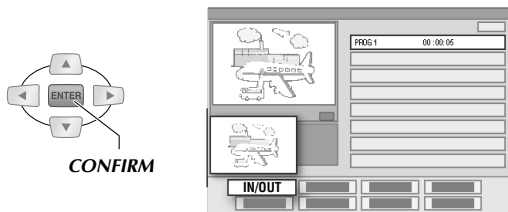

- The image of the start point for the scene will be displayed on the “IN” sub-screen.

6 Decide on the end point of the scene.

1 Start playback, then pause at the scene where you want the created play list to end.

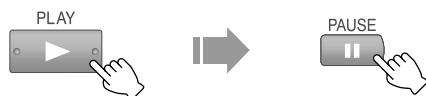

2 Confirm on the end point.

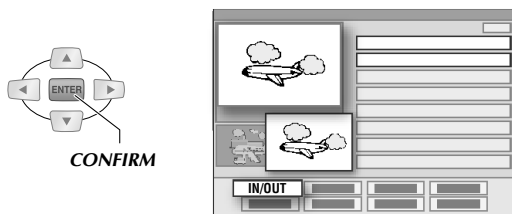

- The image of the end point for the scene will be displayed on the “OUT” sub-screen.
- Repeat step **5** and **6** to add scenes.
- To add scenes from other programmes, select “SEL. TITLE”, then repeat step **4 – 6**.
- A maximum of 99 scenes can be registered in a play list.

7 Select “OK”.

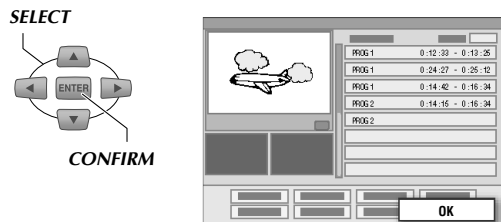

8 Select “EXIT”.



9 Exit play list creation.



■ Play back play list

- Select “PLAY LIST” in step **3** [P42] of “Basic Playback (Library Database Navigation)”.

■ Delete play list

- Perform the operations on “Deleting/Protecting a Programme”. During which, select “DELETE” under “PLAY LIST” in step **3** [P88].

NOTES:

If a scene is created, the following menu buttons can be selected.

- “SEL. TITLE”: Select scenes from other programmes.
- “MODIFY”: Modify scenes. [P86]
- “DELETE”: Delete scenes.
- “MOVE”: Can change the playback order when there are more than 2 scenes. [P87]
- “RETRY”: Cancel the last operation.
- “PREVIEW”: Play back from scene 1.
- “OK”: Confirm scene registration.

Preview Playback

- Forward search and slow motion playback are possible.
- You can move the scenes with ◀◀/▶▶.
- A scene being played back is selected.
- Press **STOP/CLEAR** to end preview playback.
- Enters into pause mode when preview playback ends.

Editing Play List



► You can modify or move the scenes of a created play list. In addition, new scenes can be added.

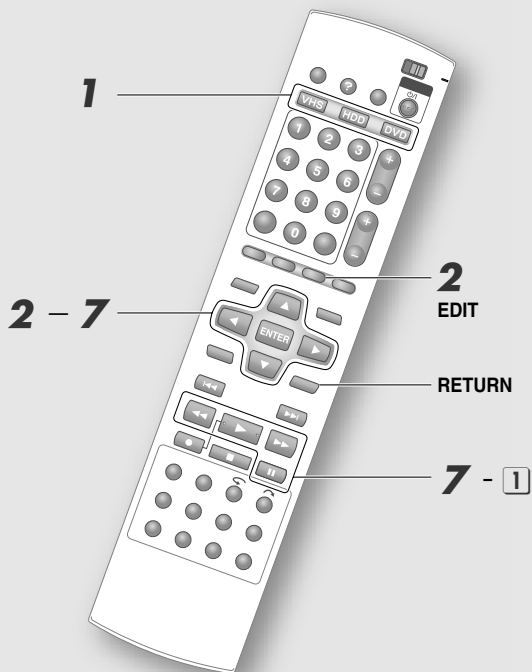

Modify Scene

1 Select disc.

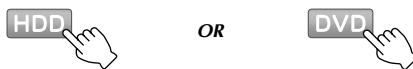

2 Display the Editing screen.

When DVD is selected

- 1 Load a disc.
- 2 Press EDIT to display the Editing screen.
- 3 Select "MODIFY".

When HDD is selected

- 1 Press EDIT to display the Editing screen.

3 Select "MODIFY" under "PLAY LIST".

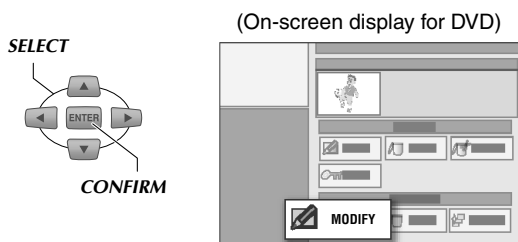

4 Select the programme to be modified.

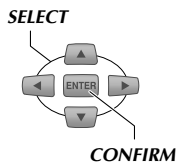

5 Select "SCENE".



6 Select the scene that you want to modify.

- 1 Select "MODIFY".

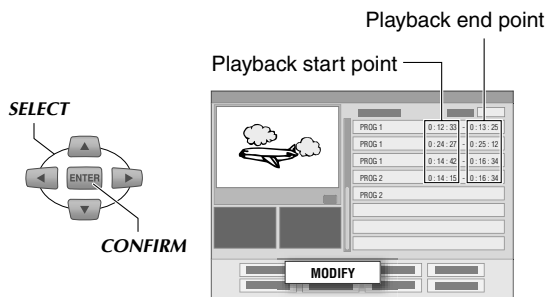

- 2 Select the playback start or end point of a scene to modify.

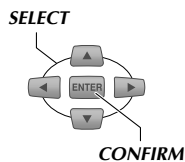

- To cancel modification, press RETURN or EDIT.

7 Create new scene.

- 1 Start playback, then pause at the desired scene.



- You can also use SLOW⊕/SLOW⊖ to search for the scene.

- 2 Confirm on the playback start or end point.

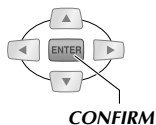

- To modify other scenes, repeat step 6 and 7.

8 Perform "Gathering Favourite Scenes (Play List Creation)", step 7 - 9 [P85].

Move Scenes

- 1 Perform step 1 - 5.
- 2 Select and confirm on "MOVE" in step 6 - 1.
- 3 Select and confirm on the scene to move at in step 6 - 2.
- 4 Select and confirm another scene to which the scene is to be moved.
 - To cancel the move, press RETURN or EDIT.
- 5 Perform "Gathering Favourite Scenes (Play List Creation)", step 7 - 9 [P85].

Add Scenes

- 1 Perform step 1 - 5.
- 2 Select and confirm on "SEL. TITLE" in step 6 - 1.
- 3 Perform "Gathering Favourite Scenes (Play List Creation)", step 4 - 9 [P84, 85].

Deleting/Protecting a Programme



- ▶ Deleting unwanted programmes can increase the disc remaining time. (However, the disc remaining time does not increase for DVD-R discs. For DVD-RW (Video mode) discs, the disc remaining time increases only when the last programme is deleted.)
- ▶ Protect function to prevent accidental erasure is available for DVD-RAM and DVD-RW/-R (VR mode) discs.

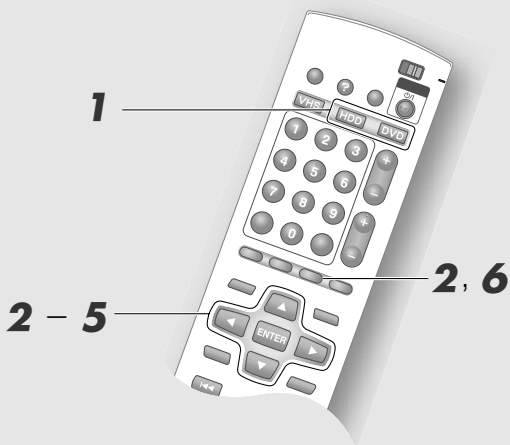

IMPORTANT:

- If an original programme is deleted, all the related play list and library information will also be deleted.
- All the programmes on a disc will be deleted once the disc is formatted even if they are protected programmes.

Deleting a Programme

1 Select disc.

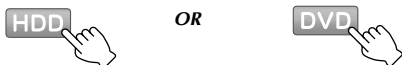

2 Display the Editing screen.

When DVD is selected

- 1 Load a disc.
- 2 Press **EDIT** to display the Editing screen.
- 3 Select **"MODIFY"**.

When HDD is selected

- 1 Press **EDIT** to display the Editing screen.

3 Select "DELETE" under "ORIGINAL".

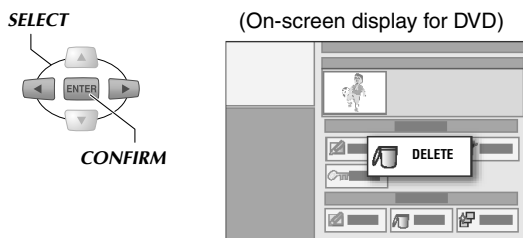

4 Select the programme to delete.



5 Select and confirm on "DELETE".

To cancel the deletion (HDD only)

- Be sure to perform before step 6.
- 1 After this step, select and confirm on the folder of the latest created **"DELETION LIST"** in the programme list. (Icon:)
 - 2 Select and confirm on the programme you want to cancel deletion.

6 Exit programme deletion.



Protect Programme (DVD-RAM/-RW(VR)/-R(VR))

- 1 Select and confirm on **"PROTECT"** in step 3.
- 2 Select and confirm on the programme to be protected.
- 3 Select and confirm on **"PROTECT"** on the confirmation screen.
 - If protect is set to a programme, a protect mark () will be placed on the programme list.
 - To remove the protection, select the programme that has been protected in 2. The "unprotect" screen is displayed, select **"CANCEL PROTECT"**.
- 4 Press **EDIT** to exit.

Deleting Scenes



- ▶ You can delete commercial breaks from a recorded programme.

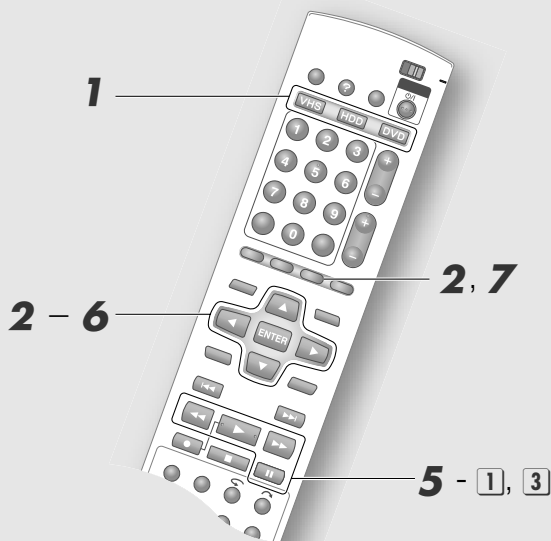

IMPORTANT:

- Deleting scenes does not increase remaining capacity for DVD-R (VR mode).
- If the time duration to be deleted is below 2 seconds, deleting may not be possible.
- It may deviate a little from the desired position set.
- Deleting scenes on the DVD will cause all related play lists to be deleted.
- Deleting scenes on the HDD is not possible if the programme is used in the play list.

1 Select disc.

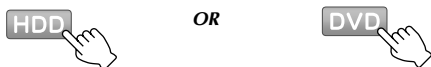

2 Display the Editing screen.

When DVD is selected

- 1 Load a disc.
- 2 Press EDIT to display the Editing screen.
- 3 Select "MODIFY".

When HDD is selected

- 1 Press EDIT to display the Editing screen.

3 Select "DEL SCEN".

SELECT

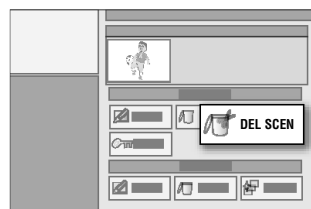
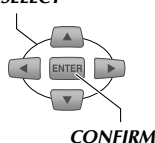

4 Select and confirm on a programme whose unwanted scenes you want to delete.

5 Decide on the unwanted scene to be deleted.

- 1 Start playback, then pause at the scene where you want the deletion to begin.



- You can also use SLOW⊕/SLOW⊖.

- 2 Select "IN".

SELECT

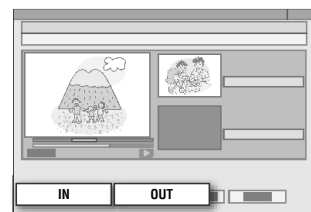
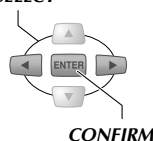

- 3 Start playback, then pause at the scene where you want the deletion to end.

- 4 Select and confirm on "OUT".

- 5 Select and confirm on "OK".

- Select "PREVIEW", a preview of the scene approximately 5 seconds before and after the deleted part is played back.
- To redo, select "RETRY".

6 Select and confirm on "DELETE".

7 Press EDIT to exit.

Dividing Scenes



- ▶ You can divide programmes that are recorded continuously.

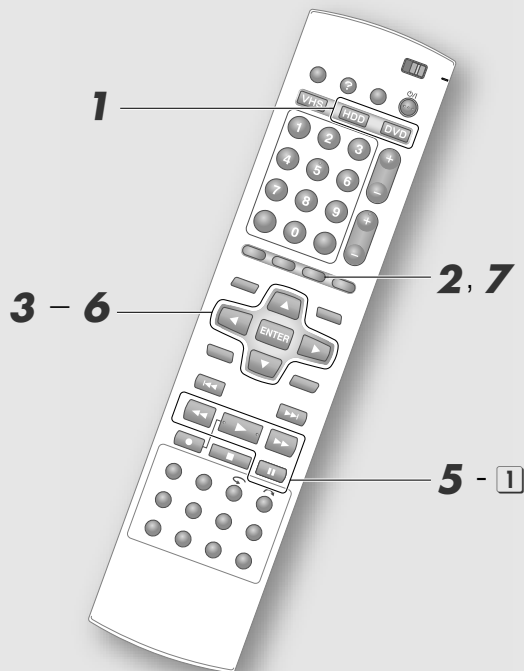

IMPORTANT:

It is not possible to divide in the following cases.

- The programme is currently being recorded.
- The programme is weekly/daily recorded and is specified for weekly/daily overwrite.
- The programme is used in the play list.
- When the number of registered programmes reaches 500.

1 Press **HDD**.

2 Display the **Editing** screen.



3 Select **"DIVIDE"** under **"ORIGINAL"**.



4 Select and confirm on a programme to divide.

5 Search for scenes to divide.

- 1** Start playback, then pause at the scene to divide.



- You can also use **SLOW+**/**SLOW-**.

- 2** Select and confirm on **"DIVIDE"**.

- 3** Select and confirm on **"OK"**.



- Select **"PREVIEW"**, the first 10 seconds of the later half of the divided programme is played back.
- To redo, select **"RETRY"**.

6 Select and confirm on **"DIVIDE"**.

7 Press **EDIT** to exit.

Help Guide

- ▶ When you encounter problems with the operating procedures, the help guide displays advices on operations that are closely related to the current usage condition.

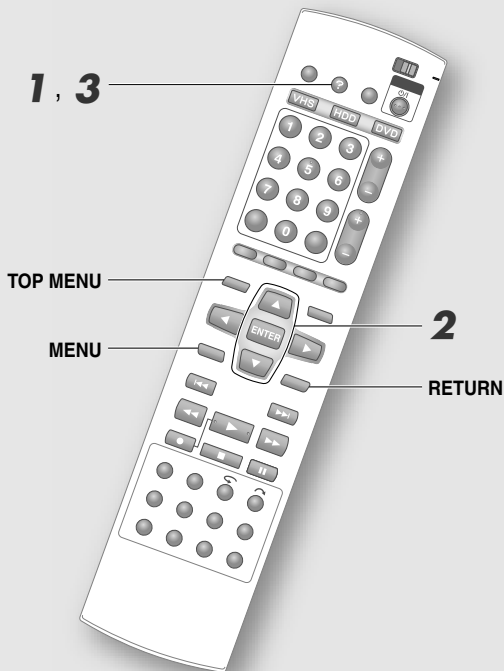

IMPORTANT:

- While the help guide is being displayed, operations such as recording and playback is not possible. In addition, the GUIDE Plus+ system or the timer programme setting screen cannot be displayed.
- Icons
 - : VHS related explanations
 - : HDD related explanations
 - : DVD related explanations
- If the VHS deck is selected during HDD ↔ DVD dubbing, the **HELP** button cannot be operated.

1 Access the “HELP” menu.

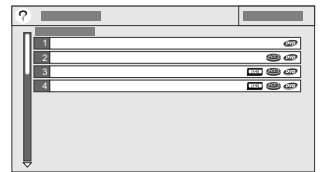

- An index containing items relating to the currently displayed screen appears. If there are no particular items to relate to, the first page of the index will be displayed.
- The index page can be advanced using **TOP MENU** or **MENU**.

2 Select an item of interest.

SELECT

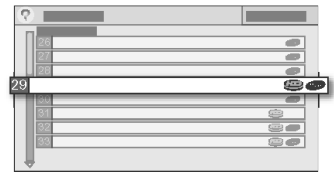
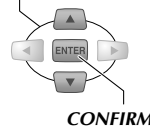

- The explanation page will be displayed.



- You can browse the explanation page using the **Selection Keys** (△▽).
- To return to the “INDEX” screen, press **RETURN**.

3 Exit the “HELP” screen.



Recording Mode



▶ The recording mode is the setting for the compression level when recording images. The image quality and recording time are related.

■ Recordable Time According to Recording Mode

(Hours: The numbers shown are estimates.)

Recording mode	VHS (when using E-240)	DVD (single-sided disc)	HDD (by temporary recording setting) (160 GB)			
			OFF	30 MIN	1 HR	3 HR
DV	-	-	11	11	11	11
XP	-	1	34	33	32	31
SP	4	2	69	68	67	64
LP	8	4	138	136	135	127
EP	-	6	209	206	203	192
FR480	-	8	300	297	283	277

- The recording time changes in accordance with the temporary recording setting. “Temporary Recording” [P96]
- The shorter the recordable time, the higher the image quality.

DV mode

Supports only HDD recording. Records in the same format as a DV camcorder.

XP/SP mode

Recommended for recording sports programmes and other fast-action programmes.

LP mode

Recommended for recording dramas and other slow-action programmes with little contrast.

EP/FR480 mode

Recommended when there is no spare recordable time (disc remaining time), or for programmes with clear outlines like in animations.

FR (Free Rate) Mode

- The numbers of the FR mode represent the recordable time (in minutes, estimated) in a DVD disc.
- FR60 - FR360 can be set by 5-minute intervals, then follow by FR420 and FR480. FR60 is almost equivalent to XP in terms of image quality; the same goes for FR120 to SP, FR240 to LP, and FR360 to EP.
- It may not be possible to play back discs recorded in FR420 or FR480 mode on other units.
- FR mode can also be set for HDD. (“JUST” cannot be set.)

Set using the disc remaining time/recording mode list

- 1 Press **DVD**, and load a disc.
- 2 Display the disc remaining time/recording mode.

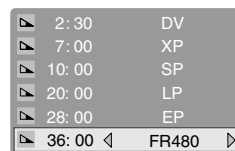

Disc remaining time/recording mode list

- 3 Move to “FR***”, and use the Selection Keys (◀▶) to change the FR mode number.
- 4 Check the disc remaining time.
 - Set to “FR***” which slightly exceeds the desired recording time.
- 5 Press **ENTER**.

If recording a 25-minute programme five times on the same disc

- $25 \times 5 = 125$, thus record using FR125 mode.

Recording on a blank DVD

In SP mode

In FR125 mode



Only four times' portion can be recorded.

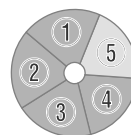

Able to fit recording to one disc.

JUST mode setting (when timer recording to a DVD disc)

- The unit automatically sets the appropriate FR mode depending on the disc remaining time.
- Set “REC MODE” to “JUST” at the recording setting for timer programming.

Example

Automatically sets FR mode for recording a 30-minute programme, on a disc with 20 minutes remaining time in XP mode.

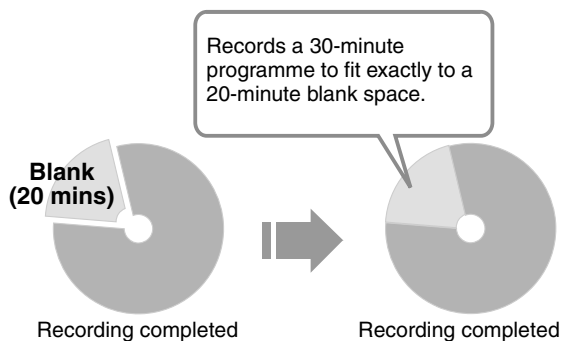

- The maximum recording time for JUST mode is equivalent to FR480 mode.

DV Mode

■ Main characteristics

- High image quality recording mode above XP mode.
- There is no image deterioration when dubbing from a DV camcorder to the HDD using the DV terminal.
- Timer recording in DV mode is possible with the exception of input from the DV terminal.
- For programmes recorded in DV mode,
 - play lists can be created. (Not possible when there is a mixture of programmes recorded in other recording modes.)
 - they can be divided by editing.
- When playing back programmes recorded in DV mode,
 - the same playback operations as other modes are possible. However, 1.5x speed with sound is not possible.
 - they can also be output from the DV terminal. (Only when using “dv” channel.)
 - temporary recording will be stopped.
- When recording in DV mode,
 - playback on the HDD or DVD is not possible.
 - Library Database Navigation, editing, and dubbing operations cannot be performed.
 - there will be no output from the DV terminal.
- During recording, the following operations are not possible for programmes recorded in DV mode.
 - Playback (“ORIGINAL” and “PLAY LIST”)
 - Editing of play list
 - Thumbnail modification
 - Chapter creation
 - Deleting of scenes
 - Dividing of scenes
- When playing back copy-once programmes, there will be no output from the DV terminal.
- Post-recording is not possible, as with a DV tape recorder.
- See the following page if recording a bilingual programme using DVD-RW/-R (Video mode). “Sound” [P100]
- Set the channel of this unit to “dv” when connecting to a DV device.
- This unit outputs to the DV device only when its channel is set to “dv”.

Weekly/Daily Timer Programming



- ▶ Programmes can be timer recorded regularly on a daily or weekly basis.
- ▶ Recorded programmes set for weekly/daily recording overwrite on the HDD can be kept. (Overwrite protection)

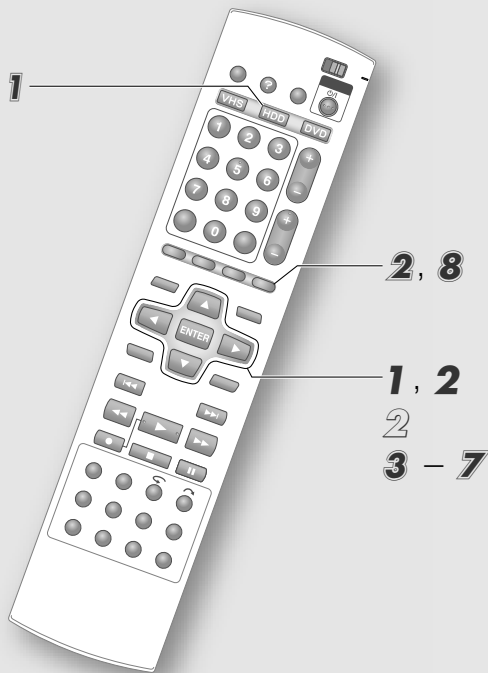

Weekly/daily recording settings

Set when timer programming or when changing the timer programme.

With HDD as the recording deck

WEEKLY/DAILY	Execution of timer recording	Icon
ONE TIME RECORD	Once only	
WEEKLY	Weekly	
WEEKLY (KEEP 1)	Weekly (overwrite)	
MON-FRI	Daily	
MON-SAT		
MON-SUN		
MON-FRI (KEEP 5)	Daily (weekly overwrite)	
MON-SAT (KEEP 6)		
MON-SUN (KEEP 7)		
MON-FRI (KEEP 1)	Daily (daily overwrite)	
MON-SAT (KEEP 1)		
MON-SUN (KEEP 1)		

With DVD as the recording deck

Only “ONE TIME RECORD”, “WEEKLY”, “MON-FRI”, “MON-SAT”, and “MON-SUN” settings are available, there is no overwrite specification.

Auto title grouping (HDD)

Weekly/daily recorded programmes will be grouped. Groups will be displayed as folders in the thumbnail list of the Library Database Navigation, editing, and dubbing screens.

A list screen of individual recorded programmes will be displayed when the folder is selected.

Grouping is available only for programmes not set for overwriting.

1 Select a folder.

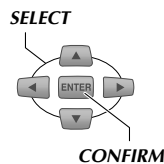

2 Select a programme.

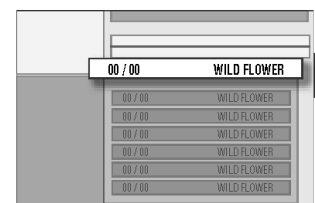
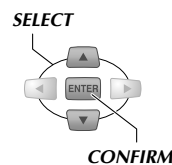

- To delete a folder, delete all the programmes in it.

Simple timer programming for the following week

1 Press **PROG** when playing back a recorded programme.

2 Select “**YES**”.

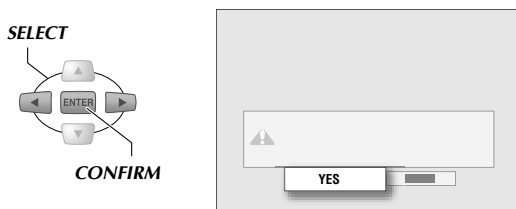

- If there is inactivity for approximately 5 seconds, the programme navigation screen will be displayed. To cancel, press **PROG**.
- If there is inactivity for approximately 1 minute during setting, the settings will be cancelled and the screen will return to the broadcast screen.

3 Set timer at the programme navigation screen.

- For timer setting, perform step **5–7** on P54, 55.
- After the timer recording has been set, the broadcast screen is displayed.

Overwrite protection setting for weekly/daily recording (HDD)

When you wish to keep programmes specified for overwriting, set overwrite protection. Or, dub to DVD disc.

1 Set to **HDD**.



2 Display the Library Database Navigation screen.





3 Select and confirm on “**NAME**”.

4 Select and confirm on the initial letter of the programme name.

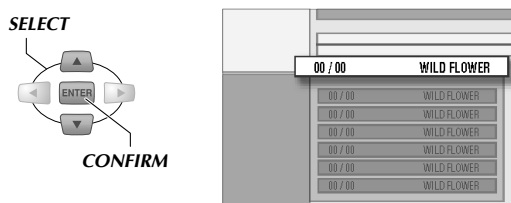
5 Select and confirm on the programme that you wish to protect.



- Icon specifying weekly/daily overwrite (, ) will be attached.

6 Select “**PROTECT**”.





7 Press **ENTER**.

8 Exit.



■ Programme alert message

- For HDD timer programming, if there is a timer programme that cannot be recorded within the duration set due to the remaining capacity of HDD, a programme alert message will be display when the unit is turned on.
- If “PROGRAMME LIST” is selected and confirmed, the “PROGRAMME LIST” screen will be displayed. Verify, cancel or change the timer programme where necessary. “Checking, Changing or Cancelling a Timer Programme” [ P57]
- The display duration of the programme alert can be set. **Setup Menu** “PROGRAMME ALERT” [ P112]  27

Temporary Recording



- ▶ After turning on this unit, temporary recording will automatically take place for only the time duration that has been set while you are watching TV.
- ▶ You can play back missed scenes (RetroActive Playback), or record from the beginning of the programme you are currently watching (RetroActive Recording).

- You can also perform Resuming Playback [P61] and One Touch Replay [P61].

Setting Time Range for Temporary Recording

1 Access the setup menu.



2 Select "HDD/DVD SET UP" → "HDD SET UP" → "LIVE MEMORY".

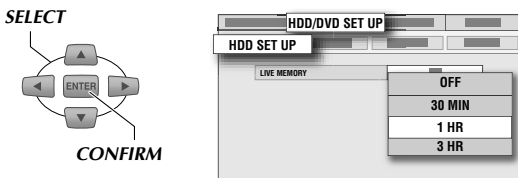

3 Select and confirm on other than "OFF".

- Time range "OFF", "30 MIN", "1 HR" or "3 HR" can be set.
- If the time range is exceeded, temporarily recorded images will be overwritten.

4 Exit.



Using the Temporary Recording Function

To play back the previous part of a TV programme currently watching (RetroActive Playback)

- 1 Search for the playback position, then start playback.

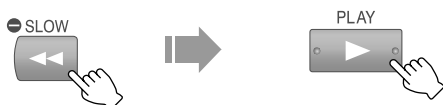

To record the previous part of a TV programme currently watching (RetroActive Recording)

While watching a TV broadcast,

- 1 Search for the record start point, then set to pause.

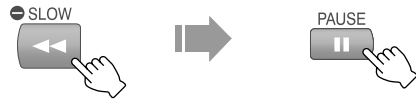

- 2 Start recording.

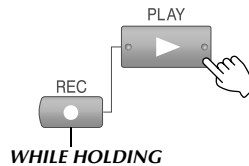

- You can also use REC (●) on the unit.
- Returns to the on-air screen after a few seconds.

- 3 End recording.



RetroActive Recording

- The recording mode is "FR65".
- When recording is in progress on the DVD, temporary recording stops.
- Temporary recording data will be automatically erased, in the following instances.
 - When the unit is turned off, or after recovering from a power failure.
 - When normal recording, timer recording, RetroActive Recording or digital timer recording is performed.
 - When the following setting is changed. "LIVE MEMORY" [P110] 09
 - When tuner channel setting is performed.
 - When the dubbing screen is displayed.
 - When DV input is selected.
 - When the image output format is switched.
 - When a programme in DV mode is played or edited.

Timer Recording



- ▶ The following describe the measures and caution points to note during timer recording.

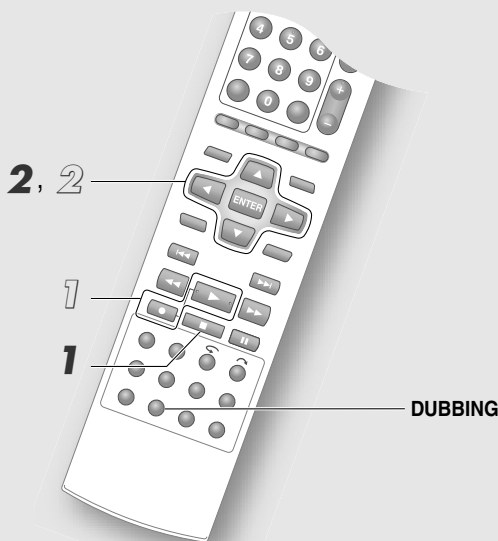

NOTES:

- Timer recording on the VHS is not possible.

Relief Recording

- If the remaining capacity of the HDD is insufficient, relief recording is not possible.

To stop timer recording (cancel)

- 1 Press STOP/CLEAR.**
- 2 Select and confirm on “CANCEL” on the confirmation screen.**

To switch from timer recording to normal recording

- 1 While holding REC, press PLAY.**
- 2 Select and confirm on “EXECUTE” on the confirmation screen.**

- To extend the recording time, activate Instant Timer Recording after switching to normal recording. [P39]

Relief Recording

A programme that is set for timer recording on the DVD will be recorded to the HDD in the following instances. The recording mode will revert to the mode previously set.

In the case of JUST mode, the recording will be in XP mode.

- Disc is not loaded.
- A non-recordable disc is loaded.
- The disc remaining time of the DVD disc is insufficient.
- DVD disc playback in progress.

Points to take note on timer recording

- Timer recording is not possible during editing.
- If a copy prohibited programme is received at the start of timer recording or during recording, recording will be paused. Recording starts again when a recordable programme is received. (For DVD only. For HDD, a black image is displayed.)
- With calendar timer programming, the starting portion of the programme may not be recorded. In addition, if the stop time of the previous timer recording coincides with the start time of the next programme, the last part of the previous programme may not be recorded.
- The programme listing data download is given priority from 03:00 to 04:30, and VPS/PDC recording cannot be performed properly. Set “VPS/PDC” to “OFF” if performing timer recording at this time.

Dubbing and timer recording priority

If a dubbing that has been set coincides with a timer recording, a warning will be displayed.

- To prioritise dubbing
Select “EXECUTE” to execute dubbing. Timer recording will not be performed. However, if the dubbing ends before the timer recording end time is reached, timer recording will be performed from the time where dubbing stops.
- To prioritise timer recording
Select “CANCEL”, then press **DUBBING**. Dubbing will not be performed.
- If the warning screen remain displayed, neither will be performed.

Managing DVDs (Library)



- ▶ Register DVD discs recorded on other units in the library. A maximum of 600 discs and 2000 titles can be registered.

IMPORTANT:

- The following discs cannot be registered in the library.
 - DVD-RAM, DVD-RW
Discs formatted using devices other than JVC DVD recorders.
 - DVD-R
New discs recorded using devices other than JVC DVD recorders.

Library

- You can also press **NAVIGATION** to register.
- If unable to register, check the following setting. **Setup Menu** "SAVE AS LIBRARY" = "ON" [📖 P111] [11]
- ▶ Select "REGISTER", and the Editing screen will appear. You can then select either "MODIFY" or "DISC NAME". [📖 P80, 82]

To Register to Library

- ① Press **DVD** and load a disc.
- ② Press **EDIT**.
- ③ Select and confirm on "REGISTER".



- ④ Press **EDIT** to exit.

To Delete from Library

- ① Press **DVD**.
- ② Press **EDIT**.
- ③ Select and confirm on "DELETE".
- ④ Select and confirm the DISC number to delete.
- ⑤ Select and confirm on "DELETE".
- ⑥ Press **EDIT** to exit.

To Search for Recorded Programmes from Library

- ① Press **HDD** or **DVD**.
- ② Press **NAVIGATION**.
- ③ Specify method for programme search.
 - For HDD library, select "NAME" or "CATEGORY".
 - For DVD library, select from "NAME", "DATE", "DISC No." or "CATEGORY".

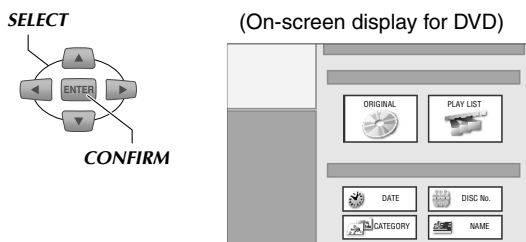

For HDD

- ④ Select the programme to play back from the list, then select the playback method.
 - "Basic Playback (Library Database Navigation)", step 4 [📖 P43]

For DVD

- ④ Check the disc number.
 - Load the relevant disc and play back from the Library Database Navigation. [📖 P42]
 - If a disc registered in the library is recorded or modified on DVD units from other manufacturers, it may not operate properly.

Recording with Best Picture Quality (VHS)



- ▶ If the B.E.S.T. (Biconditional Equalised Signal Tracking) function is used, the quality level of the tape for recording is assessed automatically to enable recording with the best picture quality.

NOTES:

- Press **VHS** to light up the VHS lamp.
- Setup Menu “B.E.S.T.” = “ON” [P115] 39

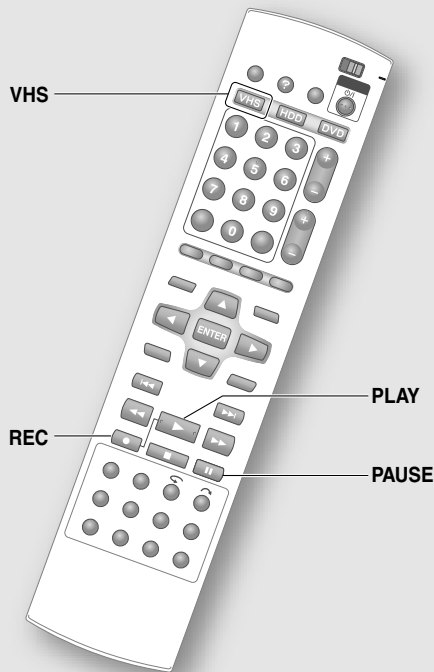

Load a tape for recording, then perform the usual steps for recording.

When recording starts, the indicator as illustrated below appears on the TV screen. When this screen is displayed, the quality level for the best recording condition on the tape is assessed.

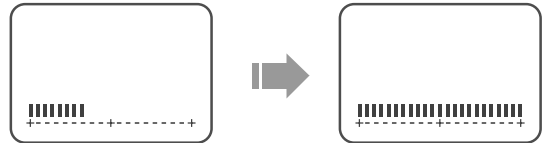

- If this screen is not displayed, set the following. Setup Menu “SUPERIMPOSE” = “AUTO” [P113] 28

To set before recording begins

- 1 Press **PAUSE** and **REC** simultaneously.
 - This unit will pause recording and assess the tape’s quality level.
- 2 When the programme that you wish to record starts, press **PLAY**.
 - Recording begins.

NOTES:















- While the tape’s quality level is being assessed, the **PAUSE** button does not function.

Assessment of the tape will be carried out in the following instances.





- When recording for the first time after loading the tape.
- When the recording mode is changed.

Sound settings (HDD, DVD-RAM/-RW(VR)/-R(VR))

This unit can receive A2 and NICAM programmes.

Programme type	On-screen display and sound output		
A2 STEREO	Stereo sound 		
A2 Bilingual	Main audio 	Sub audio 	Main+Sub audio 
	• Switches each time AUDIO is pressed.		
Regular Monaural	Normal monaural sound 		
NICAM STEREO	NICAM stereo sound 		
NICAM Bilingual	NICAM main audio 	NICAM sub audio 	
	NICAM Main+Sub audio 	NICAM FM Sound 	
	• Switches each time AUDIO is pressed. (Excluding NICAM FM Sound.)		
NICAM Monaural	NICAM monaural sound 		
External Source	Stereo 	Left audio 	Right audio 
	• Switches each time AUDIO is pressed.		

IMPORTANT:

- If receiving NICAM, set **Setup Menu** “AUDIO REC” = “NICAM” [ **P112**] **23**
- For NICAM Bilingual broadcast, NICAM FM Sound will be output when the following setting is set. **Setup Menu** “AUDIO REC” = “MONO” [ **P112**] **23**
- If connected via digital audio, set **Setup Menu** “DIGITAL AUDIO OUT” = “PCM ONLY” [ **P110**] **04**. Otherwise, the audio cannot be switched.
- DVD-RW/-R (Video mode) disc does not support bilingual sound. When recording or dubbing to these discs, set the recording sound in advance. **Setup Menu** “VIDEO MODE RECORDING AUDIO” [ **P111**] **14**
- When stereo or monaural programmes are recorded or dubbed on DVD-RAM or DVD-RW/-R (VR mode) discs, the display shown will be .

Relationship between disc type and sound output







Setup Menu “DIGITAL AUDIO OUT” [**P110**] **04**

Disc playback media	Sound format	DIGITAL AUDIO OUT setting		
		STREAM/PCM	DOLBY DIGITAL/PCM	PCM ONLY
DVD Video	48/96 kHz 16/20/24 bit Linear PCM	48 kHz 16 bit Linear PCM		
	Dolby Digital	Dolby Digital Bitstream		48 kHz 16 bit Linear PCM
	MPEG	MPEG Bitstream	48 kHz 16 bit Linear PCM	
	DTS	DTS Bitstream		
Audio CD	DTS	(No Output)		
	CD-DA	44.1 kHz 16 bit Linear PCM		
Video CD, Super Video CD	44.1 kHz 16 bit Linear PCM			
CD-ROM/R/RW	MP3	Linear PCM		

Sound settings (VHS)





Receiving A2 and NICAM programmes.





Programme type	On-screen display
A2 STEREO	ST
A2 Bilingual	BIL.
Regular Monaural	(none)
NICAM STEREO	ST NICAM
NICAM Bilingual	BIL. NICAM
NICAM Monaural	NICAM

- To listen to a stereo programme, press **AUDIO** until “HIFI L   R” appears on the TV screen.
- To listen to a bilingual programme, press **AUDIO** until “HIFI L  ” or “HIFI  R” appears on the TV screen.
- To listen to the standard (Regular Monaural) audio while receiving a NICAM broadcast, press **AUDIO** until “NORM” appears on the TV screen.
- Set the following for on-screen display. **Setup Menu** “SUPERIMPOSE” = “AUTO” [ **P113**] 

Soundtrack selection on VHS

This unit can record three sound tracks (HI-FI L, HI-FI R, NORM), one of which can be selected during playback. If **AUDIO** is pressed, the sound track changes as follows.

Track	Purpose
On-screen display	
HIFI L   R	For tapes recorded in Hi-Fi stereo.
HIFI L 	For main audio in tapes with bilingual recording.
HIFI  R	For sub audio in tapes with bilingual recording.
NORM	When listening to tapes recorded in monaural sound.
HIFI NORM	When listening to tapes with post-recording editing.

- Usually select L   R. In this mode, Hi-Fi stereo tapes are played back in stereo, and the normal audio track is played back automatically for tapes with only normal audio.
- Set the following for on-screen display. **Setup Menu** “SUPERIMPOSE” = “AUTO” [ **P113**] 

Manual Tracking/Tape Remaining Time (VHS)



▶ The auto-tracking function is automatically activated to adjust picture distortion or flickering when tape playback begins. If picture distortion or flickering cannot be removed with auto-tracking, adjust tracking manually.

NOTE:

- Press **VHS** to light up the VHS lamp.

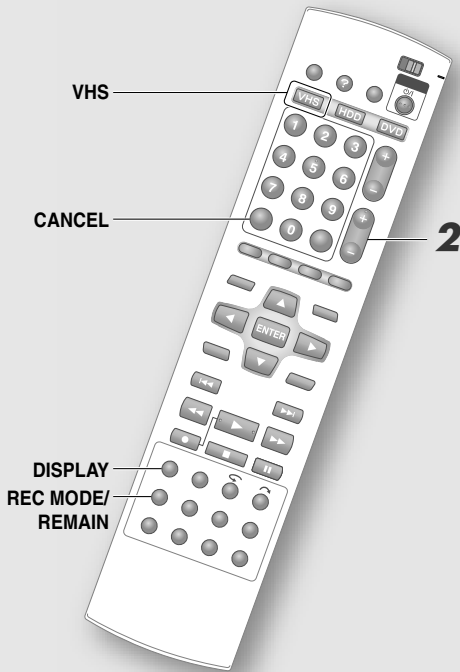

NOTES:

- You can also adjust when the picture jumps, or when horizontal lines or flickering appears during still picture or slow motion playback.
- For tapes where the recording condition is extremely bad or tapes recorded on other video cassette recorders, it may not be possible to adjust tracking adequately.
- Although picture distortion or flickering during still picture or slow motion playback may not disappear even after adjusting, it is not a malfunction.
- Noise may appear if a tape recorded in other than standard mode is played on other video cassette recorders.

To Adjust Tracking Manually

During playback

1 Disable auto-tracking.



Press + and – simultaneously.

- Auto-tracking turns on/off with each press.
- Automatic adjustment functions when auto-tracking is on, during which the picture may be distorted.

2 Adjust while viewing the picture played.

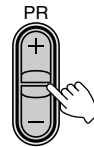

OR

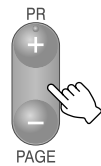

- Press + or – to adjust manually.

To Check the Remaining Time on a VHS Tape

During playback or recording



To reset the counter



- The counter on the TV screen or the front display panel becomes “0:00:00”.
- The remaining time displayed is an estimation, which is calculated using the current recording mode.
- Depending on the tape, the remaining time may not be displayed correctly.

Avoiding Misuse

- ▶ Setting the child lock will disable the buttons on the unit and the remote control.
- ▶ If the tray lock is set, the disc tray will not function even when **OPEN/CLOSE** is pressed.

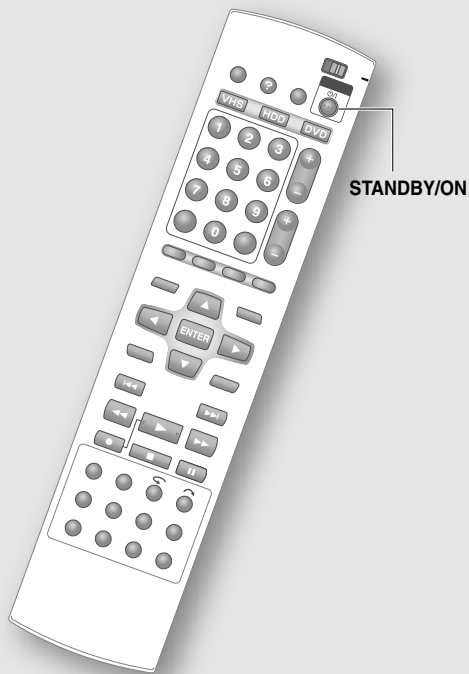

NOTE:

- Timer recording will be performed even when the child lock is set.

To Disable Operation (Child Lock)

When the unit is turned on

Press and hold *STANDBY/ON* on the remote control for more than 10 seconds.

- “CL” is displayed on the front display panel for a few seconds.

To cancel the child lock

Perform the same operation.

To Lock the Disc Tray (Tray Lock)

When the unit is turned off

While holding *STOP/CLEAR* (■) on the unit, press *OPEN/CLOSE* (▲).

- “LOCK” is displayed on the front display panel for a few seconds.

To cancel the tray lock

Perform the same operation.

- “UNLOCK” is displayed on the front display panel for a few seconds.

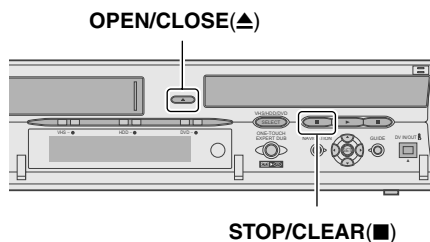

Changing Remote Control Settings

Operating a TV from Other Manufacturers

- ▶ This unit's remote control can operate the basic functions of your TV.

PREPARATION:

- Switch **TV/DVD** on the remote control to **TV**.

1 While pressing **SET UP**, enter the code number using the **Number Keys**, then press **ENTER**.

(Example) For JVC 23



- Release **SET UP** after this.

BRAND NAME	BRAND CODE
JVC	01, 23, 24, 25
FERGUSON	27
FINLUX	30
FUNAI	32
LG/GOLDSTAR	18
GRUNDIG	19
HITACHI	10
ITT	28
MITSUBISHI	03
MIVAR	29
NEC	20
NOKIA	31
PANASONIC	04, 11
PHILIPS	02
RCA	05
SAMSUNG	12, 33, 34, 35
SANYO	13, 16
SHARP	06
SONY	07
THOMSON	26
TOSHIBA	08, 14

2 Press **STANDBY/ON**.

- If the TV is not on, repeat from step 1 again. For brands with more than one code, try entering another number.
- If the remote control's batteries are removed, the brand code will revert to 01 (JVC). Re-perform the setting.

NOTE:

- Depending on the TV, some TVs may not be operable using this unit's remote control.

Using Multiple JVC Recorders

- ▶ With more than 2 devices, there may be remote control interference.

PREPARATION:

- Switch **TV/DVD** on the remote control to **DVD**.

1 While pressing **SET UP**, enter the code number using the **Number Keys**, then press **ENTER**.

- Release **SET UP** after this.

REMOTE CONTROL CODE	CODE
DVD1	1
DVD2	2
DVD3	3
DVD4	4

2 Press **STANDBY/ON** on the unit to turn off the unit.

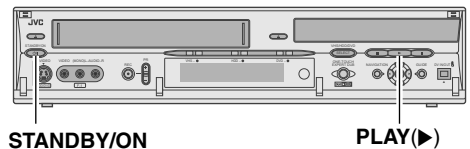

3 Press **PLAY (▶)** on this unit for more than 5 seconds.

- The code number currently set will be displayed on the front display panel.

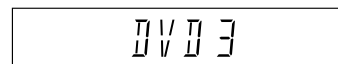

- If **Setup Menu** "DIMMER (DURING POWER OFF)" is set to "OFF", the front display panel will be off. In this case, set this setting to "ON" in advance. [P113] 31

4 Press **STOP/CLEAR** on the remote control.

- The new code number will blink on the front display panel for 5 seconds.

Screen Display

On-Screen Display

► Displays on the TV screen when **ON SCREEN** is pressed.

■ Display during recording

- During on air, when **ON SCREEN** is pressed or when the channel is changed, the programme title is displayed for approximately 5 seconds.

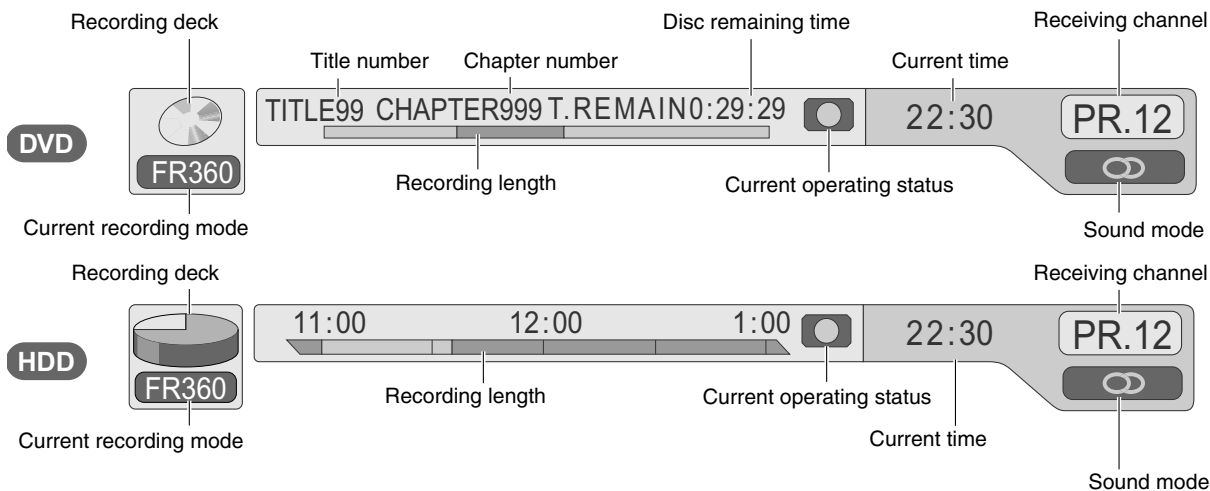

■ Display during playback

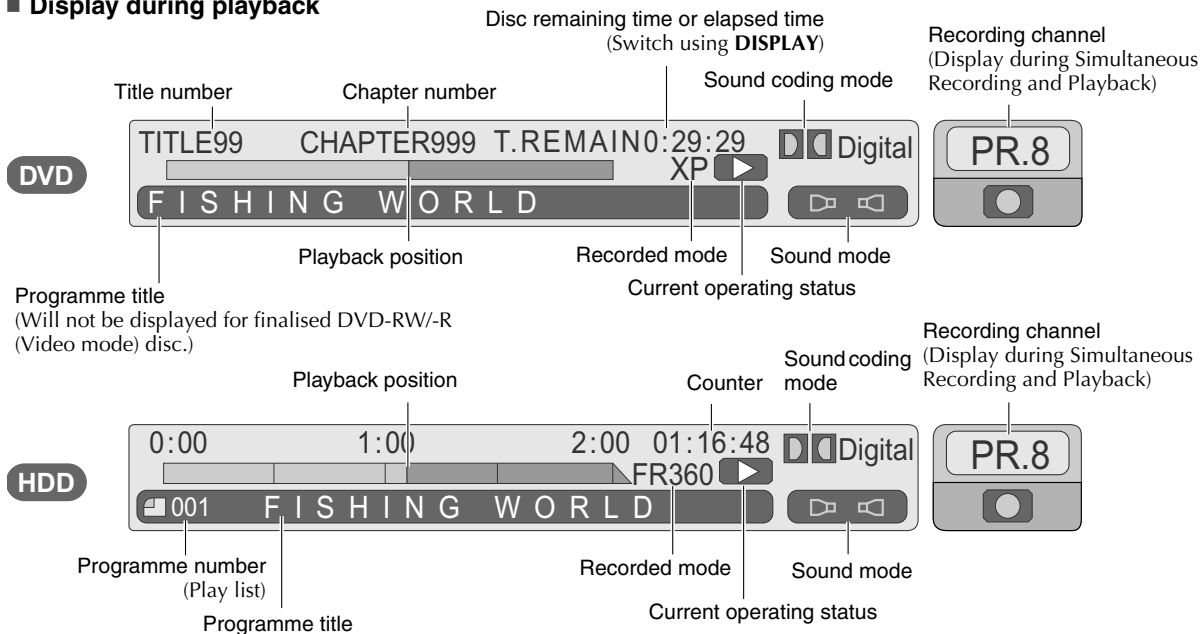

■ Display during VHS mode

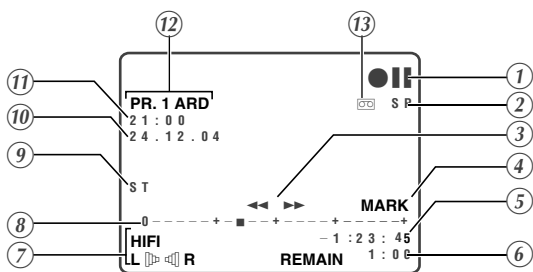

- | | |
|------------------------|--|
| ① Tape operation | ⑧ Tape position indicator |
| ② Recording mode | ⑨ Type of broadcast [P101] |
| ③ Tape direction | ⑩ Current day/month/year |
| ④ Index mark indicator | ⑪ Clock display |
| ⑤ Counter | ⑫ Channel number/station name /external input terminal |
| ⑥ Tape remaining time | ⑬ "Cassette Loaded" indicator |
| ⑦ Sound mode [P101] | |

Playback Setting Menu Operations



▶ During disc playback, use this on-screen bar to perform settings such as playback mode, image or audio mode.

PREPARATION:

- Switch TV/DVD on the remote control to DVD.

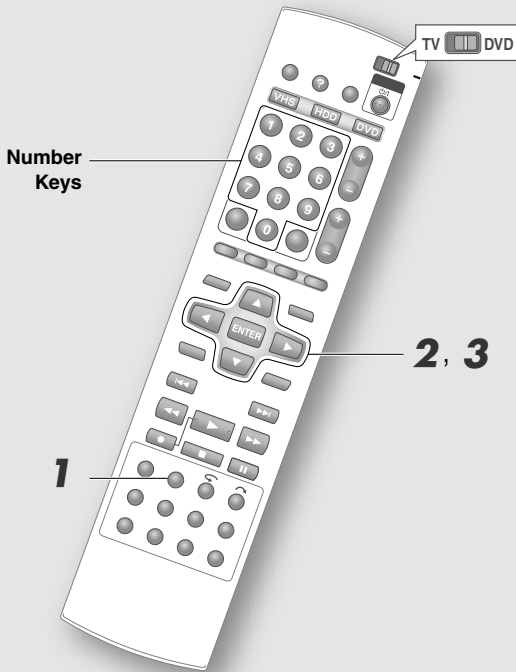

How to Use the Playback Setting Menu

1 Press ON SCREEN once or twice to display the playback setting menu.

When playing back a programme recorded on the HDD



When playing back a DVD Video disc or a programme recorded on DVD



Disc type DVD Video only

- Finalised DVD-RW-R (Video mode) discs will be indicated as “DVD-VIDEO” under disc type.
- DVD-RW and DVD-R formatted in VR mode will be indicated as “RW-VR” and “R-VR” respectively.

When playing back Video CDs or audio CDs



When playing back MP3 and JPEG files



JPEG only

2 Select the target function icon.

- Depending on the icons, some cannot be selected while playback is stopped.

3 Select the setting from the menu displayed.

- Some settings may require entry using the Number Keys.

→ Description of each setting is available from next page.

Description of Each Setting

		Repeat Playback	
HDD DVD -RAM -RW-VR -RW-VIDEO -R-VR -R-VIDEO -VIDEO V-CD CD JPEG MP3	For setting the repeat playback mode of titles, chapters, etc.		
	OFF	Plays back normally.	
	ALL REPEAT	The entire disc is played back repeatedly.	
	TITLE REPEAT	The current title is played back repeatedly.	
	CHAPTER REPEAT	The current chapter is played back repeatedly.	
	TRACK REPEAT	The current track is played back repeatedly.	

- “CHAPTER REPEAT” and “TRACK REPEAT” are not available for DVD discs.
- For HDD, only “TITLE REPEAT” is available.
- In the case of MP3/JPEG, “ALL REPEAT” becomes “FOLDER REPEAT”.
- When Video CD/Super Video CD is played back with the PBC function, setting is not possible.

		A-B Repeat Playback	
HDD DVD -RAM -RW-VR -RW-VIDEO -R-VR -R-VIDEO -VIDEO V-CD CD	For setting the start and end point for repeat playback of a desired segment.		
	A	Start point.	
	B	End point.	
	After selecting the menu, press ENTER during playback. Each time you press ENTER , setting is set in order of start point, end point and cancelling repeat mode.		

- The duration between point A and point B must be more than 3 seconds.
- Setting is possible only within the same title or track.
- If the track is changed before the end point is set, the start point will be cancelled.
- For DVD Video discs that do not contain time information, setting is not possible.

		Search Playback	
HDD DVD -RAM -RW-VR -RW-VIDEO -R-VR -R-VIDEO -VIDEO V-CD CD JPEG MP3	Specify the number and play back.		
	TITLE SEARCH	Specify a title number.	
	CHAPTER SEARCH	Specify a chapter number.	
	GROUP SEARCH	Specify a group number.	
	TRACK SEARCH	Specify a track number.	
	A number entry box appears when the menu is selected. Enter using the Number Keys . Play back using ENTER .		

- “GROUP SEARCH” and “TRACK SEARCH” are not available for DVD discs.
- For HDD, only “CHAPTER SEARCH” is available.
- “TRACK SEARCH” is only available for audio CD, Video CD and Super Video CD.
- When Video CD/Super Video CD is played back with the PBC function, setting is not possible.

		Time Search Playback	
HDD DVD -RAM -RW-VR -RW-VIDEO -R-VR -R-VIDEO -VIDEO V-CD CD	Starts playback from the specified time.		
	Specify the elapsed time from the beginning of a programme (HDD and DVD discs) or a disc (CDs).		
	TIME	Specify the elapsed time.	
V-CD CD	A time entry box appears when the menu is selected. Enter using the Number Keys . To enter 12 minutes 50 seconds, press the buttons in order of 1 , 2 , 5 and 0 . Play back using ENTER .		

- With DVD discs, setting is not possible while in stop mode.
- When Video CD/Super Video CD is played back with the PBC function, setting is not possible.
- For DVD Video discs that do not contain time information, setting is not possible.

Playback Setting Menu Operations (continued)

 Programme Playback	
V-CD CD	Play back in order of specified tracks. If selected during programme playback, normal playback will be activated.
	<p>A box for specifying the playback order appears when the menu is selected. Enter the track number in order from 1 using the Number Keys.</p> <p>For 1-digit numbers, confirm using ENTER. If you made a mistake, press CANCEL.</p> <p>Play back using PLAY.</p>

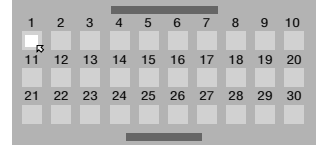

- Repeat playback is possible during programme playback.

 Random Playback		
V-CD CD	Play back all tracks in random order.	
	OFF	Plays back normally.
	ON	Plays back randomly.

 Adjusting the Picture Quality		
HDD DVD -RAM -RW-VR -RW-VIDEO -R-VR -R-VIDEO -VIDEO V-CD	The picture quality can be adjusted as desired.	
	NORMAL	Adjusts the picture quality automatically.
	CINEMA	When playing back movies, etc.
	SHARP	When playing back animation, etc.
	SOFT	When noise on the image is noticeable.

 Progressive Mode Setting		
HDD DVD -RAM -RW-VR -RW-VIDEO -R-VR -R-VIDEO -VIDEO	It is possible to set a progressive mode suited to the image.	
	AUTO	Detects film and video contents automatically. Usually select this mode.
	FILM	A mode suited to film images (such as movies).
	VIDEO	A mode suited to video images (TV broadcast, etc.). Effective for fast-moving images, animated images, etc.

 3D Surround (Simulated Surround Effect) Setting		
DVD -VIDEO	You can enjoy the surround effect of DVD Videos recorded with multi-channels, even with two speakers.	
	OFF	Deactivate the surround effect.
	ON	Activate the surround effect.

- Does not work on discs that are not recorded with multi-channels, and does not affect the bitstream of the digital audio output.
- Cannot set to “ON” when playing back DVD Video during recording (including temporary recording).
- If set to “ON”, the following settings will be disabled. **Setup Menu** “ANALOG AUDIO OUT” [P110] 05, **Setup Menu** “D.RANGE CONTROL” [P110] 06

 Display time interval for JPEG or slide show	
JPEG	For setting the display time interval for one image.
	5 sec, 10 sec, 15 sec, 20 sec, 25 sec, 30 sec

- If the file size is large, it may take a little longer than the time set.

Setup Menu

- ▶ Performing basic settings that determine the operations of this unit. Press **SET UP** to access the setup menu.

(Upper category) > (Lower category)	
No. (Setting item)	
(Description of setting contents)	
(Default setting)	(Description of setting contents)
(Other settings)	(Description of setting contents)

DVD VIDEO SET UP > LANGUAGE SET	
01 MENU LANGUAGE	
For setting the menu screen language for DVD Videos. When the selected language is not available on the disc, the disc's default menu language will be displayed.	
ENGLISH	Sets the language.
JAPANESE, GERMAN, FRENCH, ITALIAN, SPANISH, DUTCH, SWEDISH, NORWEGIAN, FINNISH, DANISH	
AA, AB, ..., ZU	Set using language code. [📖 P117]
02 AUDIO LANGUAGE	
For setting the audio language to be played on the DVD Videos. When the selected language is not available on the disc, the disc's default audio language will be played.	
ENGLISH	Sets the language.
JAPANESE, GERMAN, FRENCH, ITALIAN, SPANISH, DUTCH, SWEDISH, NORWEGIAN, FINNISH, DANISH	
AA, AB, ..., ZU	Set using language code. [📖 P117]
03 SUBTITLE	
For setting the subtitle language to be played on the DVD Videos. When the selected language is not available on the disc, the disc's default subtitle language will be displayed.	
ENGLISH	Sets the language.
JAPANESE, GERMAN, FRENCH, ITALIAN, SPANISH, DUTCH, SWEDISH, NORWEGIAN, FINNISH, DANISH	
AA, AB, ..., ZU	Set using language code. [📖 P117]
OFF	Disables the subtitle display.

Setup Menu (continued)

DVD VIDEO SET UP > AUDIO OUTPUT

04 DIGITAL AUDIO OUT

Set in accordance with the device connected to the digital audio output terminal (digital coaxial). In addition, change the setting when playing back bilingual sound. [📖 P100]

DOLBY DIGITAL/PCM	When connecting to a Dolby Digital decoder or an amplifier with built-in decoder.
STREAM/PCM	When connecting to a DTS, Dolby Digital decoder or an amplifier with built-in decoder.
PCM ONLY	When connecting to a device (MD recorder, etc.) that is compatible only with linear PCM.

05 ANALOG AUDIO OUT

Set in accordance with the device connected when playing back DVD Videos.

STEREO	When connecting to an audio amplifier or TV.
DOLBY SURROUND	When connecting to a Dolby Surround compatible amplifier.

06 D.RANGE CONTROL

For setting the compression rate of the dynamic range (ratio of the maximum volume and the minimum volume) while playing back with Dolby Digital.

NORMAL	Normal compression rate.
WIDE RANGE	Disables compression. (The effect may not be different from "NORMAL" depending on the discs.)
TV MODE	High compression rate. (Setting for TV. Even soft sound can be clearly heard.)

07 OUTPUT LEVEL

For setting the audio output level.

STANDARD	Maintains the output level.
LOW	Lowers the output level.

DVD VIDEO SET UP > DISC PLAY SET UP

08 RESUME

For setting whether to memorise the position where the disc is stopped during playback. This setting is compatible with DVD Video, finalised DVD-RW/-R disc, Video CD and Super Video CD. Resume works on other discs (JPEG files not applicable) and the HDD, regardless of this setting. However, CD-DA format discs do not support "DISC RESUME".

OFF	Do not memorise.
ON	Memorises only the disc loaded.
DISC RESUME	Memorises resume points of 30 discs.

HDD/DVD SET UP > HDD SET UP

09 LIVE MEMORY

For setting the recording time for temporary recording. [📖 P96]

OFF	Disables temporary recording.
30 MIN	Performs temporary recording for 30 minutes.
1 HR	Performs temporary recording for 1 hour.
3 HR	Performs temporary recording for 3 hours.

10 DV RECORD AUDIO

For setting the audio when recording bilingual broadcast in DV mode.

MAIN	Records the main audio.
SUB	Records the sub audio.
MAIN → L * SUB → R	Distributes the main/sub audio to the left and right.

HDD/DVD SET UP > DVD SET UP		
11 SAVE AS LIBRARY		
For setting whether to register a recorded or timer recorded programme title to the Library Database Navigation (DVD Navigation).		
	OFF	Do not register.
	ON	Register.
12 CONTINUOUS PLAY		
For setting whether to play back multiple programme titles on a disc continuously. (For finalised DVD-RW/-R (Video mode), continuous playback will be activated.)		
	OFF	Returns to the broadcast screen after playing back a programme.
	ON	Plays back programme titles on a disc in sequence.
13 VIDEO MODE RECORDING ASPECT		
For discs in Video mode, the aspect ratio of the screen is fixed for a programme. For setting the screen mode to be given priority, when the selected programmes to be dubbed from the HDD consist mix aspect ratio.		
	PRIORITIZE 4:3	Records in 4:3.
	PRIORITIZE 16:9	Records in 16:9.
14 VIDEO MODE RECORDING AUDIO		
For selecting the audio to be recorded, when recording or dubbing bilingual programmes to Video mode discs.		
	MAIN	Records the main audio.
	SUB	Records the sub audio.
15 MP3/JPEG		
For setting which type of file to play back when a disc contains both MP3 and JPEG files.		
	MP3	Plays back MP3 files.
	JPEG	Plays back JPEG files.

HDD/DVD SET UP > DISC SET UP		
16 FINALISE		
To finalise DVD-R and DVD-RW discs. This is not a setting item. [📖 P67]		
17 CANC. FINALIS.		
Cancels finalisation of DVD-RW discs. This is not a setting item. [📖 P67]		
18 FORMAT		
To format DVD-RAM, DVD-RW (VR mode, Video mode) and DVD-R (VR mode) discs. This is not a setting item. [📖 P66]		

HDD/DVD SET UP > COMMON SET UP		
19 DV AUTO CHAPTERING		
For setting whether or not to create chapters (marks), when dubbing via the DV input terminal connecting the external DV camcorder. (Press the START/STOP button on the DV camcorder to detect the screen being recorded. [📖 P74]) However, marks cannot be created for direct recording to the DVD in Video mode. Record to the HDD, then dub to the DVD.		
	OFF	Do not create chapters (marks).
	ON	Create chapters (marks).
20 DV 12-BIT AUDIO		
For setting the audio for dubbing from DV camcorder, etc.		
	SOUND1	Stereo recording of normal sound.
	SOUND2	Stereo recording of post-recorded sound.
	MIX	Mixes and records both the normal and post-recorded sound.

Setup Menu (continued)

HDD/DVD SET UP > COMMON SET UP

21 MOTION INDEX

For setting whether to set the picture on the top left of the Library Database Navigation screen or Editing screen to that of the selected programme or broadcast screen. If a programme recorded in DV mode is selected during recording or temporary recording, the broadcast screen will be displayed.

OFF	The broadcast screen will be displayed.
ON	The selected programme will be displayed.

FUNCTION SET UP > REC/PLAY SET UP

22 XP MODE REC AUDIO

For setting the audio mode when recording in XP mode. (This setting is invalid for HDD ↔ DVD dubbing.)

DOLBY DIGITAL	Normal audio mode.
LINEAR PCM	High sound quality mode.

23 AUDIO REC

Set if recording NICAM bilingual broadcasts.

NICAM	Records in bilingual mode.
MONO	Records in normal sound mode.

24 DIRECT REC

If connected with a TV supporting T-V Link, channels being watched on TV can be recorded instantly.

OFF	Disable.
ON	Enable.

25 INPUT COLOUR SYSTEM

For selecting the colour format of the image.

PAL	When recording input signals in PAL format.
SECAM	When recording input signals in SECAM format.

26 JUMP TIME

For setting the jump interval for ◀◀▶▶. [P44]

15 MIN	Jumps in 15-minute interval.
30 MIN	Jumps in 30-minute interval.
1 HR	Jumps in 1-hour interval.

27 PROGRAMME ALERT

A function to warn that there are programmes that cannot be recorded for the weekly/daily timer programming due to insufficient remaining capacity of the HDD. For setting the period where warning is required. (Displayed when the unit is turned on.)

OFF	No warning.
WITHIN 1 DAY	Warns that there are programmes that cannot be recorded within 1 day, ..., within 6 days, within 1 week, ..., within 5 weeks.
— WITHIN 6 DAYS	
WITHIN 1 WEEK	
— WITHIN 5 WEEKS	

FUNCTION SET UP > DISPLAY SET		
28 SUPERIMPOSE		
For setting whether to automatically display the operation details on the TV screen.		
	OFF	Do not display.
	AUTO	Displays for 5 seconds during operations.
29 BLUE BACK		
For setting whether to display a blue screen, when broadcast cannot be received or if there are no signals at the external input. Set to "OFF" when the signals are weak or reception is poor.		
	OFF	Do not change the screen display.
	ON	Switch to a blue screen.
30 DIMMER (DURING POWER ON)		
For setting the brightness of the front display panel when the unit is on.		
	BRIGHT	Bright
	DIMMED	Dark
31 DIMMER (DURING POWER OFF)		
For setting whether to light up or turn off the light of the front display panel when the unit is off.		
	OFF	Turns off the light of the front display panel when the unit is off.
	ON	Lights up the front display panel when the unit is off.
32 QUICK STARTUP		
If set to "ON", the power consumption during standby increases but operations such as playback can be performed more quickly than when set to "OFF".		
	OFF	Usually set to "OFF". (Standby power consumption: 6.7 W)
	ON	Operations can be performed quickly after turning on the unit. (Standby power consumption: 16.5 W)
33 ON SCREEN LANGUAGE		
For setting the on-screen display language.		
	ENGLISH	Sets the language.
	DEUTSCH, FRANCAIS, ESPAÑOL, ITALIANO, NEDERLANDS, SVENSKA, NORSK, SUOMI, DANSK	

Setup Menu (continued)

FUNCTION SET UP > VIDEO IN/OUT

34 MONITOR TYPE

Set in accordance with the TV to be connected.

4:3LB	When connected with a 4:3 TV. (Black strips are added to the top and bottom when displaying a 16:9 image.)
4:3PS	When connected with a 4:3 TV. (The left and right are cropped off when displaying a 16:9 image.)
16:9AUTO	When connected with a wide TV (16:9).
16:9FIX	When connected with a TV fixed at 16:9. (This unit automatically adjust the screen width when displaying a 4:3 image.)

35 F-1 INPUT

Set in accordance with the video connectors to be connected, when using the [F-1] input connectors on the front panel.

VIDEO	If connecting video signals (yellow connector).
S-VIDEO	If connecting S-Video signals (black connector).

36 L-1 OUTPUT

For setting the output signal of the connector in accordance with the connecting device, when using the SCART connector [L-1] on the rear panel.

SCART VIDEO	Outputs video signals.
SCART S-VIDEO	Outputs S-Video signals.
SCART RGB	Outputs RGB signals.
COMPONENT	Outputs component video signals. (If connecting to the TV via the component terminal.)

37 L-1 INPUT

For setting the input signal of the connector in accordance with the connecting device, when using the SCART connector [L-1] on the rear panel as a input connector.

VIDEO	If connecting video signals.
S-VIDEO	If connecting S-Video signals.

38 L-2 SELECT

Setting for the SCART connector [L-2] on the rear panel. Mainly for setting the input signals accordingly when connected. Also, when this unit is turned off, signals of an external tuner can be set to be output from [L-1]. The items that can be set changes depending on the "L-1 OUTPUT" setting. [P29]

VIDEO/RGB	If connecting video signals.
S-VIDEO/RGB	If connecting S-Video signals.
SAT VIDEO/RGB	If connecting video signals with an external tuner.
DECODER	If connecting a decoder.

INITIAL SET UP > TUNER SET

For setting receiving channels. [P36]

INITIAL SET UP > CLOCK SET

For setting the clock. [P34]

- ▶ Performing basic settings that determine the operations of VHS. Press **VHS** to set to VHS mode, then press **SET UP** to access the setup menu.

VHS SET UP		
39 B.E.S.T.		
For recording with the picture quality that best matches the tape. [P99]		
	OFF	If you do not wish to use this function.
	ON	If you wish to record in the condition that best matches your tape.
40 PICTURE CONTROL		
For selecting the best picture quality during playback.		
	AUTO	When you wish to adjust the picture quality automatically. (Usually set to this mode.)
	EDIT	Minimises image deterioration during editing.
	SOFT	Minimises image coarseness when viewing overplayed tapes containing a lot of noise.
41 COLOUR SYSTEM		
This unit can play PAL, NTSC and MESECAM tapes, and record SECAM signals. Select an appropriate colour system.		
	PAL/NTSC	When recording PAL signals, or playing PAL or NTSC tapes.
	MESECAM	When recording MESECAM signals, or playing MESECAM tapes.

TV Station and ID List

- The “ID” abbreviation is what is shown on-screen in lieu of the station name. The “ID” abbreviation is listed in the Confirmation screen and is displayed on the TV screen when the unit is tuned to a different station.

ID	STATION NAME	ID	STATION NAME	ID	STATION NAME
1000	TV1000	JIM	JIM TV	SHOW	SHOW
3SAT	3SAT	JSTV	JSTV	SIC	SOCIEDADE
9LIV	9LIVE	KA2	KA2	SKY	SKY CHANNEL
AB3	AB3	KAB1	KABEL1	SKYN	SKY NEWS
ADLT	ADULT	KAN2	KANAL2	SPEK	SPEKTRUM
ANIM	ANIMAL PLANET	KAN5	KANAL5	SPRT	SPORT
ANT3	ANTENA3	KBH	KBH.KANAL	SRTL	SUPER RTL
ARD	ARD	KIKA	KINDER.KANAL	STAR	STAR-TV
ARTE	ARTE	LA7	LA7	SVT1	SVT1
ATV	MAGYAR ATV	LIB	LIBERTY TV	SVT2	SVT2
B1	BERLIN 1	LOCA	LOCAL	SV24	NEWS
BBC	BBC GROUP	M6	M6	SWR	SUEDWEST3
BBC1	BBC1	MBC	MBR	TCC	TCC
BBC2	BBC2	MCM	MCM	TCM	TCM
BBCW	BBC WORLD	MDR	MDR	TELE	TELE
BIO+	TV BIO+	MOVE	MOVIE	TEL5	TELES
BLOO	BLOOMBERG	MTV	MTV	TF1	TF1
BR3	BAYERN3	MTV1	MTV1	TM	TV DE MADRID
C+	CANAL PLUS	MTV2	MTV2	TMC	TELEMONTECARLO
C1	PORTUGUSES	MTV3	MTV3	TMF	TMF
C9	VALENCIA	NGEO	NATIONAL.G	TNT	TNT INT
CAN5	CANALE5	N24	NEWS24	TRT	TRT INT
CANV	KETNET CANVAS	N3	NORD3	TSI1	TSI
CANZ	KANAAL Z	N-TV	N-TV	TSI2	TSI2
CH4	CHANNEL4	NBC	NBC SUPER	TSR1	TSR
CH5	CHANNEL5	NDR	NDR	TSR2	TSR2
CHLD	CHILD	NED1	NED1	TV1	BRTN TV1
CINE	CINEMA	NED2	NED2	TV2	TV2
CLUB	TELECLUB	NED3	NED3	TV2Z	TV2 ZULU
CMT	CMT	NET5	NETWORK5	TV3	TV3
CNN	CNN	NEWS		TV3+	TV3 PLUS
CSUR	ANDALUCIA	NICK	NICKELODEON	TV4	TV4
CT1	CT 1	NOVA	NOVA	TV5	TV5
CT2	CT 2	NRK1	NRK	TV6	TV6
DISC	DISCOVERY	NRK2	NRK2	TV8	TV8
DK1	DENMARK1	ODE	ODEON	TVE1	TVE1
DK2	DENMARK2	ORF1	ORF1	TVE2	TVE2
DK4	DENMARK4	ORF2	ORF2	TVG	TV GALICIA
DR1	DR TV	PHOE	PHOENIX	TVI	TV INDEPENDENT
DR2	DR2	POLS	POL SAT	TVN	TV NORGE
DSF	DSF	PREM	PREMIERE	TV24	TVN24
DUNA	DUNA TV	PRIM	PRIMA TV	TVP1	TVP1
ETB1	ETB1	PRO7	PRO7	TVP2	TVP2
ETB2	ETB2	RAI1	RAI1	TV P	TV POLONIA
ETV	ETV	RAI2	RAI2	V8	V8
EUNW	EURO NEWS	RAI3	RAI3	VCR	VIDEO
EURO	EURONEWS	RET4	RETE4	VH-1	VH-1
EUSP	EUROSPORTS	RTB1	TELE21	VIT	VITAYA
FEMM	FENMAN	RTB2	RTVF1/2	VIVA	VIVA
FILM	FILM	RTL	RTL	VIV2	VIVA2
FNET	FILMNET	RTL2	RTL2	VMTV	VIDEO MUSIC
FR2	France2	RTL4	RTL4	VOX	VOX
FR3	France3	RTL5	RTL5	VSAT	VIASAT3
FR5	France5	RTL7	RTL7	VT4	VP4
GALA	GALAVISION	RTLK	RTLK	VTM	VTM
HBO	HBO	RTP	RTP	WDR3	West3
HR3	HESSEN3	RTV4	RTV4	WRLD	WORLD
HSEU	H.S.EURO	SAT1	SAT1	YLE1	YLE1
INFO	INFO-KANAL	SBS6	SBS	YLE2	YLE2
ITA1	ITALIA1	SERV	Service	YORN	YORIN
ITA7	ITALIA7	SF1	SF1	ZDF	ZDF
ITV1	ITV	SF2	SF2	ZTV	ZTV

Language Code List

AA	Afar	IN	Indonesian	RU	Russian
AB	Abkhazian	IS	Icelandic	RW	Kinyarwanda
AF	Afrikaans	IW	Hebrew	SA	Sanskrit
AM	Ameharic	JI	Yiddish	SD	Sindhi
AR	Arabic	JW	Javanese	SG	Sangho
AS	Assamese	KA	Georgian	SH	Serbo-Croatian
AY	Aymara	KK	Kazakh	SI	Singhalese
AZ	Azerbaijani	KL	Greenlandic	SK	Slovak
BA	Bashkir	KM	Cambodian	SL	Slovenian
BE	Byelorussian	KN	Kannada	SM	Samoan
BG	Bulgarian	KO	Korean (KOR)	SN	Shona
BH	Bihari	KS	Kashmiri	SO	Somali
BI	Bislama	KU	Kurdish	SQ	Albanian
BN	Bengali, Bangla	KY	Kirghiz	SR	Serbian
BO	Tibetan	LA	Latin	SS	Siswati
BR	Breton	LN	Lingala	ST	Sesotho
CA	Catalan	LO	Laothian	SU	Sundanese
CO	Corsican	LT	Lithuanian	SW	Swahili
CS	Czech	LV	Latvian, Lettish	TA	Tamil
CY	Welsh	MG	Malagasy	TE	Telugu
DZ	Bhutani	MI	Maori	TG	Tajik
EL	Greek	MK	Macedonian	TH	Thai
EO	Esperanto	ML	Malayalam	TI	Tigrinya
ET	Estonian	MN	Mongolian	TK	Turkmen
EU	Basque	MO	Moldavian	TL	Tagalog
FA	Persian	MR	Marathi	TN	Setswana
FJ	Fiji	MS	Malay (MAY)	TO	Tonga
FO	Faroese	MT	Maltese	TR	Turkish
FY	Frisian	MY	Burmese	TS	Tsonga
GA	Irish	NA	Nauru	TT	Tatar
GD	Scots Gaelic	NE	Nepali	TW	Twi
GL	Galician	OC	Occitan	UK	Ukrainian
GN	Guarani	OM	(Afan) Oromo	UR	Urdu
GU	Gujarati	OR	Oriya	UZ	Uzbek
HA	Hausa	PA	Panjabi	VI	Vietnamese
HI	Hindi	PL	Polish	VO	Volapuk
HR	Croatian	PS	Pashto, Pushto	WO	Wolof
HU	Hungarian	PT	Portuguese	XH	Xhosa
HY	Armenian	QU	Quechua	YO	Yoruba
IA	Interlingua	RM	Rhaeto-Romance	ZH	Chinese
IE	Interlingue	RN	Kirundi	ZU	Zulu
IK	Inupiak	RO	Rumanian		

Preparations

**Which discs are unplayable?
Can I use cartridge-enclosed DVD-RAMs?**

See “About Discs” [P12].

Can I replace the HDD on my own?

No. This unit’s HDD contains software required for operations, and will not function if replaced with a commercially available HDD.

My television is not equipped with video inputs, is there other methods of connection?

Use an RF converter sold separately. For details on connection, refer to the instruction manual of the RF converter.

Setup

The HDD is functioning although the unit is not on.

The HDD functions in the following instances even if the unit is off.

- While receiving programme listing data.
- While HDD is being optimised.

The fan is functioning although the unit is not on.

The fan spins in the following instances even if the unit is off.

- While receiving programme listing data.
- During VPS/PDC recording standby.
- When **Setup Menu** “L-2 SELECT” = “DECODER” [P114] 38

Can I watch programmes via the external receiver even though the unit is not on?

Yes, this unit outputs signals from the [L-2 IN/DECODER] terminal to the [L-1 IN/OUT] terminal even if it is off. See “Input/Output Setting” [P29]

However, this function is not available during programme listing data downloading. In such cases, it is recommended that the external receiver be connected directly to the TV.

Images output from this unit are vertically squeezed.

Set **Setup Menu** “MONITOR TYPE” = “16:9AUTO” [P114] 34

Recording

The time of the clock seems to deviate.

See “Clock Setting” [P34].

Can I record simultaneously on the HDD and DVD?

No. This unit is equipped with only one tuner. It is not possible to record simultaneously on two or more decks.

If I record to full capacity on the disc, will the old recordings be erased?

It will not be erased. Recording will stop.

Can I switch the channel while recording is paused?

Yes, on the DVD deck. However, it is not possible to switch to DV input. Switching is not possible during DV input recording.

Cannot activate pause while HDD is recording.

Unable to pause recording on the HDD. If **PAUSE** is pressed while HDD is recording, it will enter into Live Memory Playback’s pause mode. However, record pause is possible during external input recording. (By pressing **REC** and **PAUSE** on the remote control simultaneously.)

Cannot switch between the main and sub audio after recording a bilingual programme onto the DVD-R disc.

DVD-RW/-R (Video mode) recording will be recorded in the sound as set. **Setup Menu** “VIDEO MODE RECORDING AUDIO” [P111] 14

When recording movies and other bilingual programmes, the use of DVD-RAM or DVD-RW (VR mode) discs is recommended.

While recording on the VHS, the channel cannot be changed even if I switch to the DVD or HDD.

As the VHS and DVD/HDD share the same tuner on this unit, the channel cannot be changed while recording is in progress even if you switch the deck.

What happens to the chapter (mark) during recording?

	HDD, DVD-RAM, DVD-RW/-R (VR mode)	DVD-RW/-R (Video mode)
During recording	Inserted when switched from monaural or bilingual broadcast to stereo broadcast.	Automatically inserted approximately every 5 minutes.
During dubbing	Marks will be copied.	Marks will be copied.

- Chapters (marks) will not be copied for play list dubbing. Each scene becomes a chapter.
- For dubbings to the DVD-RW/-R (Video mode) discs, up to 99 marks per title are copied.

Playback

Does not perform as operated when playing a commercially available DVD Video.

There are some DVD Videos and Video CDs with playback controls set by the disc maker.

Can I perform reverse playback (-1x speed playback) on Video CDs?

No. Reverse slow playback is also not possible.

Unable to perform 1.5x speed playback for HDD.

1.5x speed playback cannot be performed while recording on HDD or DVD.

- Perform after recording ends.

When does the memory for resume get cancelled?

The memory for resume will be cancelled when any of the following is performed.

- Pressing **STOP/CLEAR** while stopped.
- Selecting titles from the DVD Video menu screen. (And when setup menu is set to "DISC RESUME".)
- Turn off this unit.
- Removing the disc.

Thumbnails on the DVD deck are not displayed.

Set the channel to other than "dv".

When the channel has been set to "dv", the thumbnails will not be displayed when using a disc that is not registered in the library.

Dubbing

Can I dub commercially available DVD Videos to the HDD?

Commercially available DVD Video discs are copy-guarded for copyright protection purposes. Dubbing is not possible in this case.

Can I control the DV camcorder connected to the DV terminal?

Yes, but some models cannot be controlled.

During HDD ↔ DVD dubbing, will the programme information be copied?

The recording date and time, channel, thumbnail pictures, and chapter marks will be copied.

Can I change the recording mode when dubbing from the HDD to DVD?

HIGH SPEED dubbing:

Dubs using the same recording mode as the HDD.

JUST dubbing:

Dubs using the same recording mode as the HDD, but when the disc remaining time is insufficient, dubbing will be performed using a lower recording mode.

MANUAL dubbing:

Can change to a mode lower than the recording mode of the HDD.

What is the shortest dubbing time from the HDD to DVD?

Theoretical figures during high speed dubbing are as the numerical values below. (For a 1-hour programme recorded in XP mode.)

- DVD-RAM (Ver. 2.1/3x): Approx. 20 mins. (Max. 3x speed)
- DVD-RW (Ver. 1.2/4x): Approx. 15 mins. (Max. 4x speed)
- DVD-R (General Ver. 2.0/8x): Approx. 8 mins. (Max. 8x speed)

During DV dubbing, the image is not output properly from the camcorder connected to this unit.

Turn off the camcorder, then turn on and try again.

Editing

Recorded programme cannot be edited.

It is not possible to edit if a title protect mark is displayed at the bottom left of the thumbnail for DVD disc. Edit after removing title protect. [📖 P88]

To delete a part of a recorded programme.

Possible with HDD, DVD-RAM and DVD-RW/R (VR mode) discs. [📖 P89]

Operations cannot be performed after deleting programmes.

When many programmes are deleted at once, wait until the next operation can be performed.

Troubleshooting

Resetting

“PLEASE” and “WAIT” display alternately, or “RESETTING” blinks for a long time after the power plug is inserted. Is it a malfunction?

- It normally takes about 40 seconds to prepare before you can start any operations. Operations cannot be performed during this period.
- If the display does not seem to disappear, reset the unit. Press **STOP/CLEAR** (■) and **STANDBY/ON** on the unit simultaneously for more than 2 seconds until “RESETTING” is displayed on the front display panel. Or pull out the power plug, wait around 5 seconds and then re-insert.

Not functioning while “WAIT” blinks on the front display panel.

The unit is automatically repairing recorded data that is unusual. Wait until the time display is displayed. Repairing may take more than 1 hour.

The disc tray does not open.

It can be removed by force using the following method.

- ① Press **STOP/CLEAR** (■) and **STANDBY/ON** on the unit simultaneously for more than 2 seconds until “RESETTING” is displayed on the front display panel.
- ② Press and hold **OPEN/CLOSE** (▲) on the unit until the disc tray opens. (Takes about 30 seconds.)
- ③ After removing the disc, press **OPEN/CLOSE** (▲) to close the disc tray. (The unit will turn off.)

General

No power is supplied to the unit.

The power cord is disconnected from the socket.

The channel cannot be changed.

Channel cannot be changed during recording.

The remote control does not work.

- The setting of the remote control code (1/2/3/4) is inappropriate. [📖 P104]
- The batteries may be depleted.
- Remove the batteries, re-insert after more than 5 minutes and then try again. Alternatively, replace with new batteries.

Dubbing from the Video Cassette Recorder is not possible.

The external input channel “F-1” setting is inappropriate. [📖 P22]

The on-screen text displayed when playing back on this unit is recorded during dubbing.

Set to the following setting. **Setup Menu** “SUPERIMPOSE” = “OFF” [📖 P113] 28

The unit does not operate.

- Child lock has been set. Cancel the child lock. [📖 P103]
- There are cases when the operation is prohibited, depending on the disc.
- If the unit cannot be operated at all, turn off the unit, and then on again. (Lightning or static electricity may cause malfunction of the unit.)

“LOCK” is displayed on the front display panel, and the disc cannot be removed.

Cancel tray lock using the following method. While holding **STOP/CLEAR** (■), press **OPEN/CLOSE** (▲) on the unit when the unit is in standby mode. “UNLOCK” is displayed on the front display panel when tray lock is released.

Playback

No images on the TV screen.

Check if the video input is displayed. Switch the TV (AV TV) with video/audio input terminals to the external input connected to this unit.

Images do not appear on the TV screen or images are distorted.

Check the output format of the image. Refer to the above mentioned for checking method.

- Playback does not start or stops immediately after pressing **PLAY**.
- “NO DISC” is displayed on the front display panel.

- Place the disc on the disc tray with the playback surface facing down.
- A disc not compatible with this unit is loaded. [📖 P12]
- The disc loaded is dirty. Use a soft cloth to clean. [📖 P13]
- The disc loaded is badly warped or scratched.

Images are distorted when you start high speed search.

Images are distorted at the point where the playback speed changes. It is not a malfunction.

RetroActive Playback does not start.

For HDD, set **Setup Menu** “LIVE MEMORY” [📖 P110] 09 to other than “OFF”.

Live Memory Playback does not start.

For DVD, Live Memory Playback cannot be performed other than on DVD-RAM discs. Use a DVD-RAM disc. [📖 P12]

Playback does not start.

- The programme has reached its ending portion. Press **ON SCREEN** to confirm. [📖 P105]
- The recording has just completed. Wait approximately 30 seconds, then press **PLAY**.
- It may not be possible to record, play, edit, or dub discs recorded or formatted on other players or computers, on this unit. In addition, noise may appear on the screen or the sound may be distorted.

There is no sound from the coaxial output when performing 1.5x speed playback on the HDD.

To output sound from the coaxial digital sound output terminal on the rear of this unit, check the following setting.

Setup Menu "DIGITAL AUDIO OUT" = "PCM ONLY"
[📖 P110] 04

The main and sub audio cannot be switched when the coaxial digital sound output terminal on the rear of this unit is connected.

For multi-channel programmes recorded on the DVD-RAM or DVD-RW (VR mode) discs, check the following setting when the main audio and sub audio cannot be switched.

Setup Menu "DIGITAL AUDIO OUT" = "PCM ONLY"
[📖 P110] 04

After setting, press **AUDIO** to select the desired audio.

Recording

- The desired programme cannot be recorded.
- No images on the TV screen.

The channel does not correspond to that in the receiving area. If you are unable to select the desired channel on this unit, set the correct channel for the receiving broadcast. [📖 P24, 36]

Recording cannot be made.

- No disc is loaded. Or an incompatible disc is loaded. Load a recordable disc. [📖 P12]
- The disc loaded is not formatted. Format the disc so that it can be recorded on this unit. [📖 P66]
- A finalised disc is loaded. Recording cannot be made on finalised discs. [📖 P67]
- Discs formatted on other players may not be recordable on this unit.
- The disc does not have enough space. Delete unwanted programmes, or load a new disc. [📖 P88]

The unit does not turn off after completing timer recording.

The unit will not turn off in the following instances.

- DVD or VHS is selected while HDD is timer recording (and vice versa).
- When multiple timer recordings were programmed for different decks.

Timer programming cannot be made.

- Confirm the contents of the timer programme. May not function properly when there is a power failure. [📖 P56, 57]
- If timer programming cannot be set or cancelled, wait for about 1 minute and then try again.

The GUIDE Plus+ system

This troubleshooting covers only a few problems. For a complete list, please visit the GUIDE Plus+ system website at www.europe.guideplus.com

The programme listing is not displayed.

- It takes 24 hours to download the programme listing data. After checking the connections such as antenna connection, set this unit to standby mode.
- Confirm that there are no problems with the host station channel.
- After deleting channels with poor reception, perform initial setup again.

The channel does not change when receiving via the external receiver.

The IR blaster (G-LINK) cable is incorrectly connected or placed. Also, check the external receiver's brand name, etc.

Timer programming cannot be set.

The date and time is not set. [📖 P34]

The recorded programme ends halfway.

Due to circumstances of the broadcast station, the programme broadcasting time may change but this unit does not automatically change its programmed time accordingly.

Others

"- : - -" is displayed on the front display panel.

Displays when power failure occurred. Set the date and time.

The disc remaining space does not increase even though all recorded programmes have been deleted.

The DVD-RAM disc contains data recorded on a computer. Computer data cannot be deleted on this unit. If the data is unwanted, format the disc on this unit. [📖 P66]

DVD discs recorded on this unit cannot be played on other players.

- DVD-RAM discs recorded on this unit cannot be played on incompatible DVD players.
- Even finalised discs may not be playable, depending on their recording condition.

On-screen Message

■ Playback

	Message	Advice
HDD	NO TITLE RECORDED	Record a programme first.
	UNABLE TO GO FORWARD ANY MORE	Unable to advance to the end position of the programme or a position ahead of the current recording position.
	UNABLE TO GO BACK ANY MORE	Unable to return to a position before the start of recording.
DVD	COPY PROHIBITED CAN NOT PLAY	The unit has detected invalid contents of copy restrictions when reading the disc or in the middle of playback.
	DISC NOT LOADED	Load a disc.
	DISC NOT REGISTERED IN THE LIBRARY REGISTER DISC?	A disc that is not registered in the library has been loaded. Register as necessary. Registering is useful when watching the disc later on. [📖 P98]
	NAVIGATION IS NOT AVAILABLE WITH THIS DISC	Library Database Navigation cannot be utilised with DVD Videos or discs recorded and not finalised on other units.
	REGION CODE ERROR	This unit can play discs with region number “2” or “ALL”. Discs with other region numbers are not playable.
	UNREADABLE DISC CHECK THE DISC	Check if the disc can be play back on this unit. [📖 P12]

■ Recording

	Message	Advice
HDD	CAN NOT MODIFY LIVE MEMORY TIME, DUE TO SHORTAGE OF CAPACITY DELETE UNWANTED TITLE THEN RETRY	There is no recordable space remaining in the hard disk. Increase the recordable space by dubbing the currently recorded programmes to DVD first, then delete the programmes. [📖 P88]
	CAPACITY IS FULL, CAN NOT RECORD DELETE UNWANTED TITLE	Delete unwanted programmes. [📖 P88]
	REMAINING CAPACITY IS SMALL DELETE UNWANTED TITLE	
	CAPACITY IS FULL RECORDING STOPPED	Delete unwanted programmes. In addition, dub programmes that you want to the DVD discs and then delete.
DVD	COPY PROHIBITED CAN NOT RECORD	An attempt has been made to record copy-protected programmes. Use a CPRM compatible disc in VR mode when recording copy-once (programme that can only be recorded once) programmes. However, programmes with copy guard cannot be recorded.
	DISC NOT RECORDABLE INSERT RECORDABLE DISC	Load a disc that is recordable on this unit. [📖 P12]
HDD/DVD	TITLE MEMORY IS FULL, UNABLE TO RECORD DELETE UNWANTED TITLE	Up to 99 titles can be registered on a DVD, and 500 titles on the HDD. Delete unwanted programmes. [📖 P88]

■ Timer Programming

	Message	Advice
HDD	CAN NOT SET TIMER PROGRAMME DUE TO SHORTAGE OF CAPACITY DELETE UNWANTED TITLE OR CHANGE RECORD MODE	There is no recordable space remaining in the hard disk. Increase the recordable space by dubbing the currently recorded programmes to DVD first, then delete the programmes. [P88]
	CAN NOT PERFORM TIMER RECORDING CHECK PROGRAMME LIST TO CONFIRM	For HDD timer programming, there are timer programmes that cannot be recorded within the duration set due to the remaining capacity of HDD. Verify, cancel or change the timer programme from the programme list where necessary. [P57]
HDD/DVD	SET CLOCK BEFORE TIMER PROGRAMMING	Set the clock. [P34]

■ Dubbing

	Message	Advice
HDD/DVD	CAN NOT DUB DURING RECORDING STOP RECORDING THEN RETRY	Dub after recording ends.
	THE i.LINK DEVICE THAT YOU HAVE CONNECTED IS NOT RECOGNIZED MAKE SURE THAT DEVICE IS CONNECTED PROPERLY AND POWERED ON	Check that the DV device is correctly connected to the DV input terminal on the unit's front panel.

■ Disc

	Message	Advice
DVD	COULD NOT CANCEL DISC FINALISATION CHECK THE DISC	The disc may be dirty. Clean the disc and try again.
	COULD NOT FINALISE THE DISC CHECK THE DISC	
	COULD NOT FORMAT THE DISC CHECK THE DISC	

Specifications

GENERAL

Power requirement

AC 220 V – 240 V ~, 50 Hz/60 Hz

Power consumption

Power on: 45 W
Power off: 6.7 W

Temperature

Operating: 5°C to 35°C
Storage: -20°C to 60°C

Operating position

Horizontal only

Dimensions (WxHxD)

435 mm x 96 mm x 384 mm

Weight

6.9 kg

VIDEO/AUDIO (DVD Deck)

Recordable disc

DVD-RAM 12 cm (4.7 GB/9.4 GB *1)
DVD-RAM 8 cm (1.4 GB/2.8 GB *2)
DVD-R 12 cm (4.7 GB)
DVD-R 8 cm (1.4 GB)
DVD-RW 12 cm (4.7 GB)
DVD-RW 8 cm (1.4 GB)

*1 9.4 GB double-sided discs

*2 2.8 GB double-sided discs

Recording format

DVD-RAM : DVD Video Recording format
DVD-R : DVD Video format, DVD Video Recording format
DVD-RW : DVD Video format, DVD Video Recording format

Recording time

Maximum 8 hours (with 4.7 GB disc)
(XP) : Approx. 1 hour
(SP) : Approx. 2 hours
(LP) : Approx. 4 hours
(EP) : Approx. 6 hours
(FR) : Approx. 1 hour - 8 hours

Audio recording system

Dolby Digital (2 ch)
Linear PCM (XP mode only)

Video recording compression system

MPEG2 (CBR/VBR)

VIDEO/AUDIO (HDD Deck)

Capacity

160 GB

Recording time

(DV) : Approx. 11 hours
(XP) : Approx. 34 hours
(SP) : Approx. 69 hours
(LP) : Approx. 138 hours
(EP) : Approx. 209 hours
(FR480) : Approx. 300 hours

Audio recording system

Dolby Digital (2 ch)
Linear PCM (XP mode only)

Video recording compression system

MPEG2 (VBR)

VIDEO/AUDIO (VHS Deck)

Signal system

PAL colour signal and CCIR monochrome signal, 625 lines/50 fields

Recording system

DA4 (Double Azimuth) head helical scan system

Format

VHS PAL standard

Maximum recording time

(SP) : 240 min. with E-240 video cassette
(LP) : 480 min. with E-240 video cassette

Signal-to-noise ratio

45 dB

Horizontal resolution

230 lines

Frequency range

(Normal audio) : 70 Hz to 10,000 Hz
(Hi-Fi audio) : 20 Hz to 20,000 Hz

Specifications shown are for SP mode unless otherwise specified.

INPUT/OUTPUT

21-pin SCART connectors

IN/OUT X 1, IN/DECODER X 1

S-video input

Y : 1.0 Vp-p, 75 Ω
C : 0.3 Vp-p, 75 Ω

Video input

1.0 Vp-p, 75 Ω (pin jack)

Audio input

2 Vrms (pin jack)

i. Link

4-pin for DV Input/Output

Component video output

Y : 1.0 Vp-p, 75 Ω
Pb/Pr : 0.7 Vp-p, 75 Ω
Corresponding to copy protection

Digital audio output

Coaxial
Corresponding to Dolby Digital and DTS Digital Surround, Bitstream
Selectable in digital audio output setting menu

G-LINK

ø3.5 mm Jack

TUNER/TIMER

Tuning system

Frequency synthesised tuner

Signal system

PAL/SECAM colour signal, 625 lines/50 fields

TV channel storage capacity

99 positions (+AUX position)

Channel coverage

VHF : 47 MHz - 89 MHz/
104 MHz - 300 MHz/
302 MHz - 470 MHz
UHF : 470 MHz - 862 MHz

Clock reference

Quartz

Memory backup time

Approx. 10 minutes.

E. & O.E. Design and specifications subject to change without notice.

Glossary

Bitstream	Digital signals of compressed sounds or images.
Chapter	A unit for segments of music and images in the titles of DVD Videos, etc. It can be freely created for programmes recorded using this unit. (For DVD-RAM and DVD-RW (VR) discs.)
Decoder	A device that reverts compressed signals of sounds and images to their original signals.
Dolby Digital	A compression process system for audio signals. A standard system for 5.1-channel surround on DVD Videos.
DTS	An abbreviation for Digital Theater Systems, a sound compression format used on DVD Videos. With higher sound quality as compared to Dolby Digital.
Encoding	The compressing and digitalising of sounds and images. Re-encoding refers to using another system or compression rate to re-digitalise signals that were uncompressed.
Finalising	A writing process of disc information such that the programmes recorded on the DVD-R and DVD-RW discs can be played back on other players.
Intelligent Dual-Pass Encoding	Optimises the overall bit rate for recording. Scenes with rapid movement are recorded with high bit rates, while scenes with slow movement are recorded with low bit rates, thereby resulting in better picture quality.
JPEG	An abbreviation of Joint Photographic Experts Group, an international standard for compressed still image data files. The data of the 3 primary colours (RGB) is compressed from a ratio of 10:1 to 100:1.
Letterbox	A method of displaying a wide image (16:9) on a TV with aspect ratio of 4:3 in full screen, by adding a black band at the top and bottom.
Linear PCM	A format that digitalises audio signals without compression.
MP3	An abbreviation of MPEG-1 Audio Layer-3, an international standard for compressed audio data files. While minimising the deterioration of sound quality, the audio data of an audio CD is compressed to a ratio of 10:1.
MPEG	Pronounced as EHM-pehg, an abbreviation of Moving Picture Experts Group, an international standard for video and sound compression.
Pan & Scan	A method of displaying a wide image (16:9) on a TV with aspect ratio of 4:3 in full screen, by cropping off the left and right of the image.
PBC	An abbreviation of Playback Control. A mechanism that controls the playback of data recorded with Video CD (Ver.2.0). Includes a software with interactive and search function using a menu screen.
Post-recording	Refers to the adding of narration or background music (BGM) to the sound after recording it with the camera.
Progressive scan mode	For conventional TV broadcast video signals, a picture is presented by displaying the vertical resolution of 525 scanning lines alternately in halves. This system is known as interlace. The system that displays all the scanning lines at one time is known as progressive scan, and this mode enables high image quality playback of DVD Video movie softwares.
Region number	A number that restricts DVD Video playback. The world is divided into 6 regions distinguished by numbers, and playback is not possible if the number of the player and the disc do not match.
S-Video terminal	A type of video terminal that connects the unit and the peripheral devices. Achieves high image quality as the luminance signal and chrominance signal are connected separately.
Thumbnails	Reduced-size version of pictures, for making segments of pictures, programmes or scenes easily recognisable.
Title	A unit for recorded image of images that can be selected using the main image or menu screen of DVD Videos, etc. Programmes recorded using this unit are also known as titles.
Track	A unit for segments of music, images, etc. in audio CDs, Video CDs, and Super Video CDs.
Video mode	A recording system for DVD-R and DVD-RW discs, which is compatible with DVD Video discs.
VR mode	An abbreviation of Video Recording Mode. A form of recording system for discs including DVD-RW, it is possible to edit, erase or rewrite.

List of Terms

A

- A-B Repeat Playback 107
- Adjusting the Picture Quality 108
- Angle Selection 63
- Audio language 63, 109

B

- Basic Playback
(Library Database Navigation) 42
- Basic Recording 38, 40

C

- Calendar timer programming 54
- Changing or cancelling a timer
programme 56, 57
- Chapter 83, 125
- Child Lock 103
- Clock Setting 34
- Copy-once 69
- CPRM 69

D

- Decoder 29, 37, 125
- Dolby Digital 100, 110, 112, 125
- Download programme data
(The GUIDE Plus+ System) 31
- DTS 100, 125
- Dubbing 68
- Dubbing from DV Camcorder 74
- Dubbing from Video Cassette Recorder
(VCR) 75
- DV Auto Chaptering 111

F

- Finalising 67, 125
- Formatting 66
- FR (Free Rate) Mode 92
- Frame-by-frame playback 44

G

- Guide Channel Set 35
- GUIDE Plus+ System 30, 32, 46, 48, 50, 56

H

- Help Guide 91
- High speed dubbing 72

I

- Instant Timer Recording 39, 41
- Intelligent Dual-Pass Encode 69, 125

J

- JPEG 12, 65, 125
- Jump 44
- Just dubbing 72, 79

L

- Language code list 117
- Letterbox 28, 125
- Library 98
- Linear PCM 100, 110, 112, 125
- Live Memory Playback 60

M

- Manual dubbing 72
- Marks 44, 83
- Monitor type 28
- MP3 12, 65, 125

N

- NICAM 100, 112

O

- One Touch Replay 44, 61
- One-Button-Record 46
- On-Screen Language 27
- On-screen Message 122
- Overwrite protection 95

P

- Pan & Scan 28, 125
- PBC (Playback Control) 63
- Playback Setting Menu 106
- Preview Playback 85
- Programme alert 95
- Programme overlap 53, 55
- Progressive scan 64, 125

Q

- Quick startup 113

R

Random Playback 108
 Recordable time 92
 Recording Mode 40, 92
 Region number 12, 125
 Relief Recording 97
 Remote Control 17
 Repeat Playback 107
 Resetting 120
 Resume 44, 110
 Resuming Playback 61
 RetroActive Playback 96
 RetroActive Recording 96

S

Search Playback 107
 Searching Programmes 50
 Setting Receiving Channels 36
 SHOWVIEW 35, 47, 52
 Simulated Surround Effect 108
 Simultaneous Recording and Playback 60
 Skip 44
 Skip Search 44
 Slide show 65, 108
 Slow Motion Playback 44
 Sound 100
 Subtitle 63, 109
 Superimpose 113

T

Temporary Recording 96
 Time Search Playback 107
 Tray Lock 103
 TV Station and ID List 116

V

Video mode 9, 12, 66, 67, 125
 VPS/PDC 53, 55
 VR mode 9, 12, 66, 67, 125

W

Weekly/Daily Timer Programming 94

JVC